

## Signet 9950 Dual Channel Transmitter



3-9950.090 Rev. C 05/17

Operating Instructions (see pg. 10)



3-9950-1, -2



**NOTE:**

Prior to installation, Check [www.gfsignet.com](http://www.gfsignet.com) for software updates to your device. See page 48, Field Software Update, for more information.



- [English](#)
- [Deutsch](#)
- [Español](#)
- [中文](#)



### Description

The 9950 Dual Channel Transmitter is a two channel controller that can support two sensors of same or different types in one instrument. The sensor types supported by the 9950 are Signet Flow, pH/ORP, Conductivity/Resistivity, Salinity, Temperature, Pressure, Level, Dissolved Oxygen, and devices that transmit a 4 to 20 mA signal with the use of the 8058 iGo® Signal Converter.

The 9950 includes advanced features such as derived functions, advanced multiple relay modes, and timer based relay functions. Derived functions allows for the control of a relay or current loop with the sum, delta (difference), or ratio of two measurements. Multiple relay modes allow up to three signals to be used for the control of a single relay, and can be any combination of analog and binary inputs. The timer relay modes allow a relay to be activated on a repeating basis from every minute to once every 30 days. Weekday timer mode allows a relay to be energized, on a specific day or days of the week at a specific time.

The 9950 supports the following relay modules:

- Four Channel Mechanical Relay Module
- Two Mechanical and Two Solid State Relay Module
- Two Mechanical Relays and Four Binary Inputs Module

### Compatibility





The 9950 is compatible with all GF Signet products listed in the column to the right.

- pH and ORP electrodes require the Signet 2750 or 2751 DryLoc® Sensor Electronics (sold separately).
- Conductivity/Resistivity measurement requires the Signet 2850 Conductivity/Resistivity Sensor Electronics (sold separately).

Sensor Model	Freq Output	Digital (S <sup>3</sup> L) Output	Requires 8058
515/8510	X		
525	X		
2000	X		
2100	X		
2250		X	
2350		X	
2450		X	
2507	X		
2536/8512	X		
2537-5		X	
2540	X		
2551	X	X	
2552	X	X	
U1000	X		X
U3000	X		X
U4000	X		X
2260			X
2270			X
2290			X
2291			X
2610-41		X	
2724-2726		X	
2734-2736		X	
2750/2751		X	
2756-2757		X	
2764-2767		X	
2774-2777		X	
2819-2823		X	
2839-2842		X	
2850		X	

## Safety Information

- Please read entire manual before unpacking, setting up or operating this equipment. Adhere to all danger, warning and caution statements. Failure to do so could result in serious injury to the operator or damage the equipment. Make sure the protection provided by this equipment is not impaired, do not use or install this equipment in any manner other than specified in this manual.
- This unit is designed to be connected to equipment which can be hazardous to persons and property if used incorrectly.
- Read and understand all associated equipment manuals and safety warnings before using with this product.
- Remove power to unit before wiring connections.
- Wiring connections to this product should only be performed by qualified personnel.
- Do not use unit if front panel is cracked or broken.

	<b>Warning / Caution / Danger</b> Indicates a potential hazard. Failure to follow all warnings may lead to equipment damage, injury, or death.
	<b>Electrostatic Discharge (ESD) / Electrocutation Danger</b> Alerts user to risk of potential damage to product by ESD
	<b>Electrocution Danger</b> Alerts user to risk of potential of injury or death via electrocution.
	<b>Personal Protective Equipment (PPE)</b> Always utilize the most appropriate PPE during installation and service of Signet products.
	<b>NOTE / Technical Notes</b> Highlights additional information or detailed procedure

### 3-9950-2

Before commissioning the device, make sure the supply voltage matches the voltage specifications on the nameplate. For DC power input and Loop current regulated voltage, use UL60950-1 or UL61010-1 certified power supply. Power supply shall also be rated for operation at 4000 m altitude. Provide a suitable switch or circuit breaker the installation. This switch must be located close to the device (easily reached), and marked as a circuit breaker. The switch or circuit breaker to be used for power disconnect shall be certified to IEC 60947-1 and IEC 60947-3, per IEC 61010-1, Clause 6.11.4.2. Overcurrent protection (rated  $\geq 10$  A) is required for the power cable.

## Installation

For future reference, for each installation, it is recommended to record the part number and serial number of each of the components listed here:

Facility Tag Number or System ID (user assigned): \_\_\_\_\_  
 Base unit 3-9950-\_\_\_\_\_ S/N \_\_\_\_\_  
 Relay Module 3-9950.393-\_\_\_\_\_ S/N \_\_\_\_\_

### Panel Mount Installation

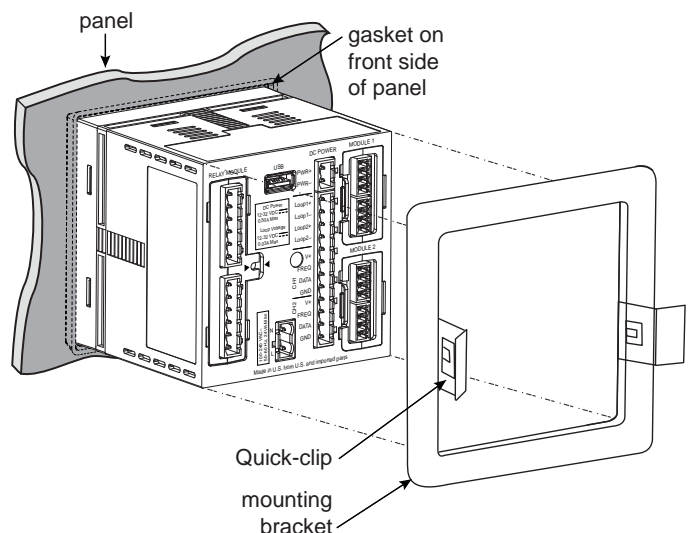
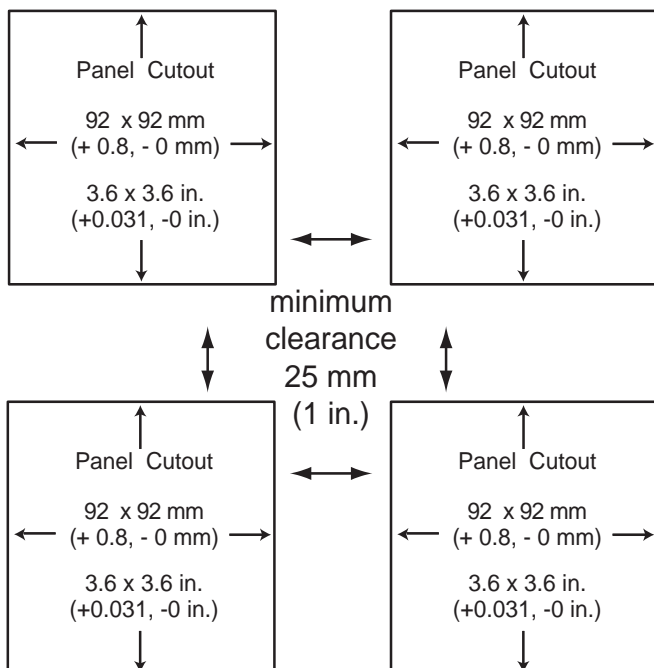

Allowable panel thickness 2.36 mm (0.093 in.) to 33 mm (1.31 in.)

## Terminal Identification

Prepare the transmitter installation location. If the back of the transmitter is difficult to access when installed, wire the removable terminal blocks first, then install it completely.

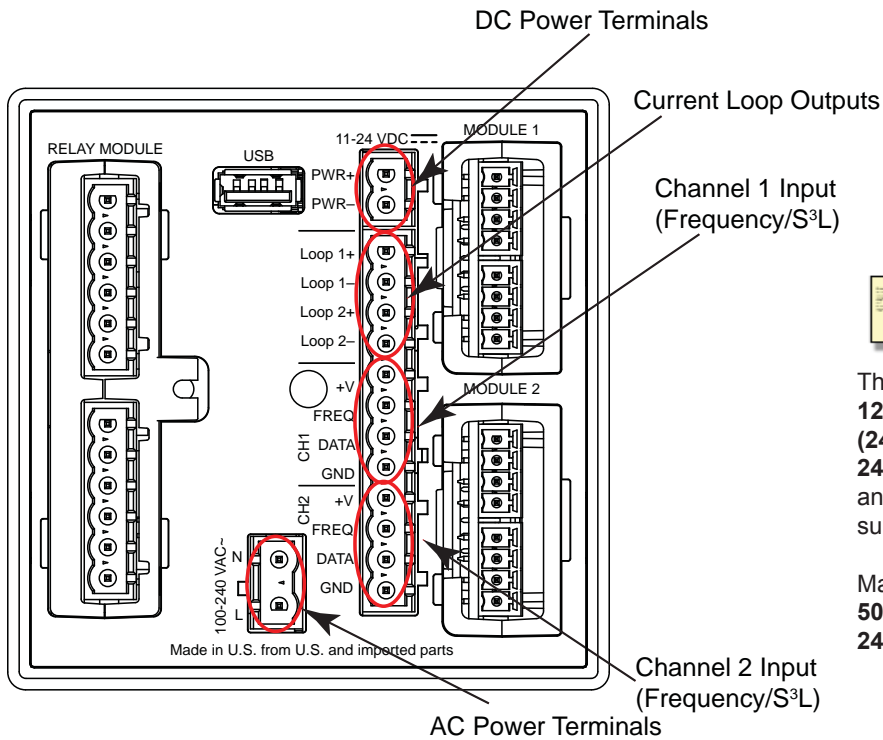

The 9950 requires regulated **12 to 32 VDC, ±10% regulated (24 VDC nominal) or 100-240 VAC at 50-60 Hz** from an external power supply (not supplied).

Maximum current draw is:  
**500 mA with DC power**  
**24 VA with AC power**

### DC Power Terminal 3-9950-1 or 3-9950-2

Required by the instrument

- 12 to 32 VDC, ±10% regulated, 0.5 A MAX. DC power input and Loop current regulated voltage require the use of a UL60950-1 or UL61010-1 certified power supply. Power supply shall also be rated for operation at 4000 m altitude.

### AC Power Terminal 3-9950-2 Only

Required by the instrument

- 100-240 VAC at 50-60 Hz, 24 VA MAX

### Relay Module

Dependent on model

- 3-9950.393-1 Four mechanical relays rated at 5A, 250 VAC or 5A, 30 VDC
- 3-9950.393-2 Two mechanical relays, 5A 250 VAC or 30 VDC, and two solid state relays rated at 50 mA, 30 VAC or 30 VDC
- 3-9950.393-3 Two mechanical relays, 5A 250 VAC or 30 VDC, and four binary inputs rated at 6 mA, 10 VDC to 24 VDC

### Channel 1 and Channel 2: Digital (S<sup>3</sup>L)/Frequency Input

- V+: +5 VDC out to sensor (black wire)
- FREQ: Frequency input signal from sensor (red wire)
- S<sup>3</sup>L DATA: Digital input signal from sensor (red wire)
- GND: Sensor ground (white wire or silver wire from paddle wheel flow sensor)

### Loop Outputs

- Two Passive 4 to 20 mA current loop outputs 12 - 32 VDC, ±10% regulated (30 mA Max)

### USB Interface

- Software updates will be provided through the USB port

## Sensor Wiring

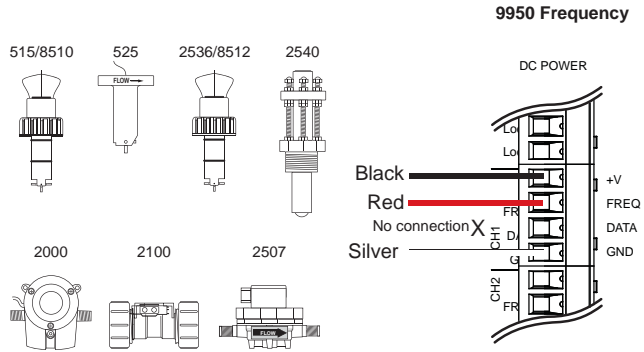

### Technical Notes:

- See corresponding product manuals for maximum cable length.
- Maintain cable shield through cable splice.
- Route sensor cable away from AC power lines.
- Select "Yes" to CH # Flow 515/525 when setting up the input on the 9950. On the 515/8510 and 525 installations, connect the silver (shield) wire to earth ground in case of EMI noise interference.

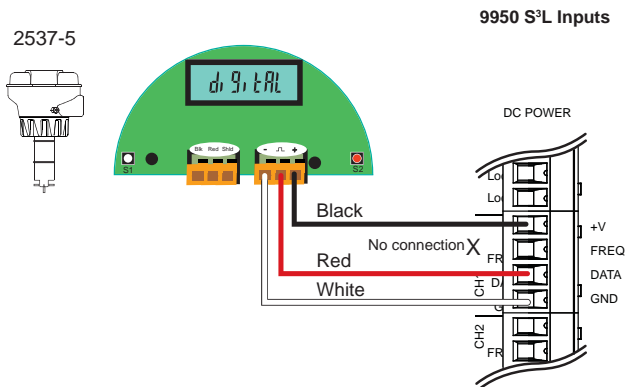

### Technical Notes:

- Wiring terminals on the 2537 are rated for 16 to 22 AWG wires.
- The cable must be 7 mm to 10 mm in diameter (0.275 in. to 0.394 in.) to seal properly in the liquid-tight connector.
- The conduit ports have 1/2-inch NPT threads. After routing the cables, seal the port with a liquid-tight conduit connector (3-9000.392-1) or with conduit.
- The 2537 models connects to the 9950 via the Digital (S<sup>3</sup>L) output.

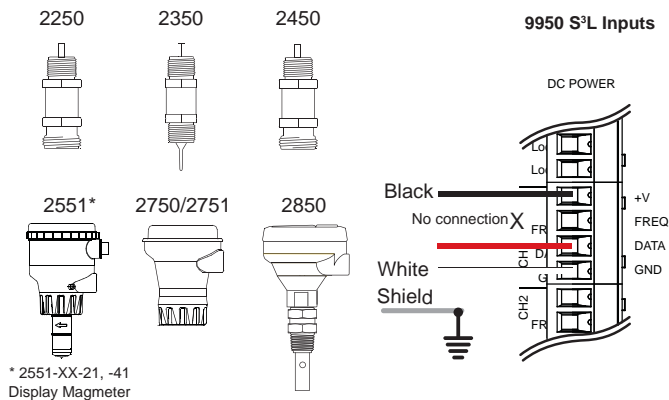

\* 2551-XX-21, -41 Display Magmeter

**NOTE:** The 2850 has no SHIELD wire.

### Technical Notes:

- Sensor dependent, see sensor manual for maximum cable length.
- Maintain cable shield through cable splice.
- Route sensor cable away from AC power lines.
- Connect the silver (shield) wire to earth ground in case of EMI noise interference.

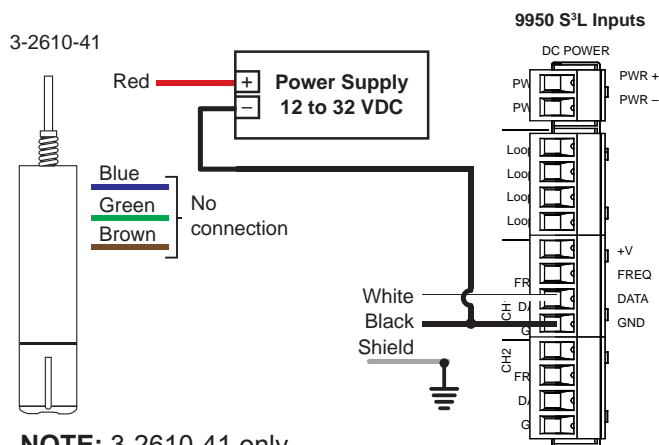

**NOTE:** 3-2610-41 only.

### Technical Notes:

The wiring of the 3-2610-41 is non-standard:

- RED is 12 to 24 VDC
- WHITE is Data
- BLACK is VDC Ground (PWR -)
- A jumper **MUST** be installed between PWR- and S<sup>3</sup>L GND.
- Use of the 3-2610-31 requires iGo Converter, refer to the 2610 Dissolved Oxygen sensor manual.

## Sensor Wiring

2551-XX-11  
Blind Magmeter

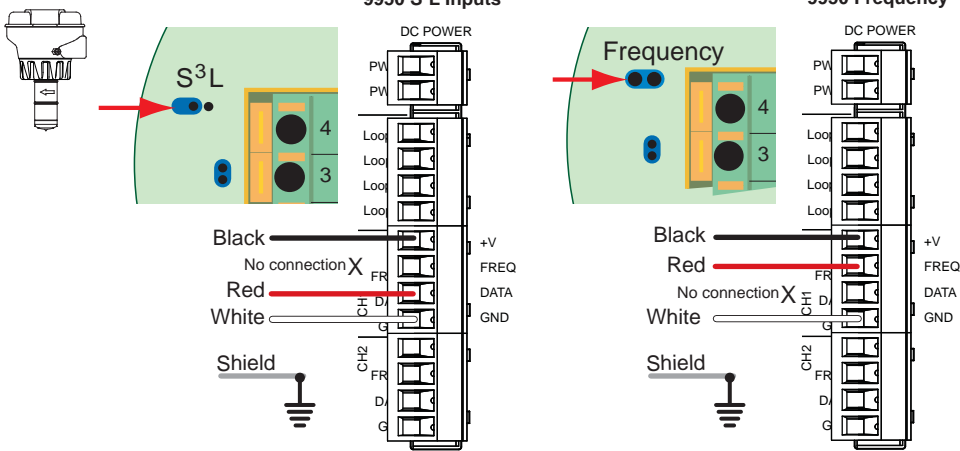

### 2551 Technical Notes:

- When the blue jumper illustrated here is placed over both pins, the 2551-XX-11 (Blind Magmeter) outputs an open collector frequency signal. When the jumper is removed (or placed over one pin for storage) the 2551-XX-11 outputs a digital (S<sup>3</sup>L) signal (recommended).

Only in case of EMI interference.  
See Frequency Output Technical Notes (2551 & 2552) at right.

### Input Wiring for 2551 and 2552 sensors

- Either Frequency or Digital (S<sup>3</sup>L) may be used.
- Signet recommends configuring these sensors with the Digital (S<sup>3</sup>L) output to display reverse flow (negative numbers).
- Input type is selected by choosing between "SENSOR FREQ" and "SENSOR S3L" in the FLOW sensor type INPUT menu (see page 29).

### Frequency Output Technical Notes (2551 & 2552):

- The frequency output will be displayed as positive flow regardless of the flow direction.
- 5 VDC power required by the 2551 & 2552 is supplied by the 9950. No additional power is required.
- Connect the silver wire (shield) to earth ground in case of EMI noise interference.

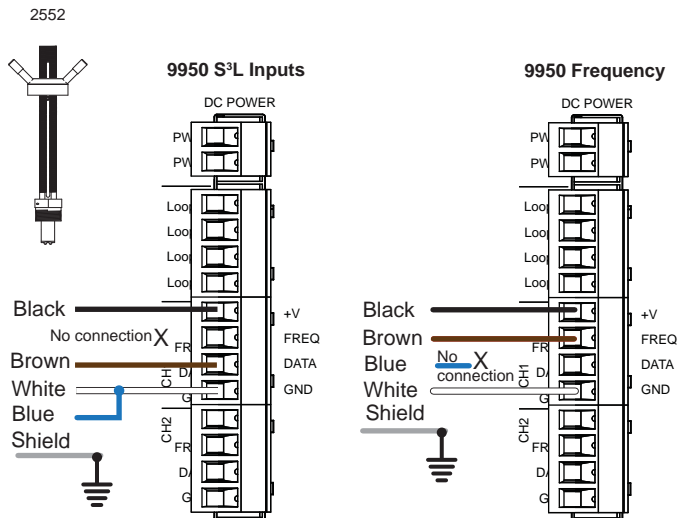

### 2552 Technical Notes:

- The 2552 outputs an open collector frequency signal that can be connected to the 9950
- Route sensor cable away from AC power lines.
- Connect the silver (shield) wire to earth ground in case of EMI noise interference.

## Power Wiring



### WARNING

DO NOT connect AC power to the DC version  
 THE 3-9950-1 MUST BE POWERED BY  
 12 - 32 VDC at 0.5 A.

3-9950-1 and 3-9950-2

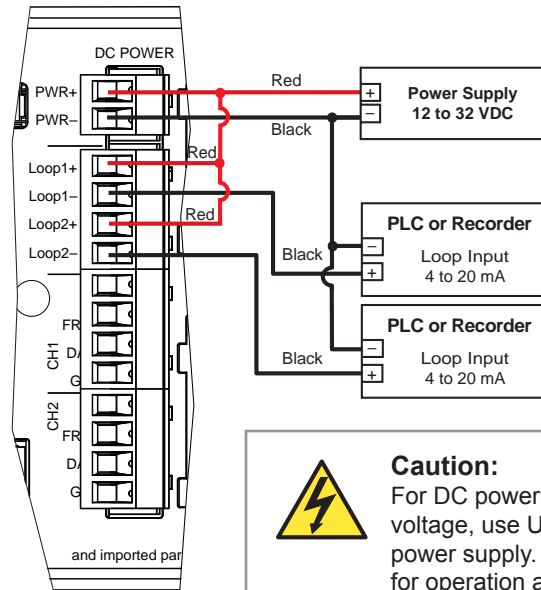

### Caution:

For DC power input and loop current regulated voltage, use UL60950-1 or UL61010-1 certified power supply. Power supply shall also be rated for operation at 4000 m altitude.



### Caution:

#### Electrical shock hazard exists!

Never connect live AC lines to the instrument.

3-9950-2

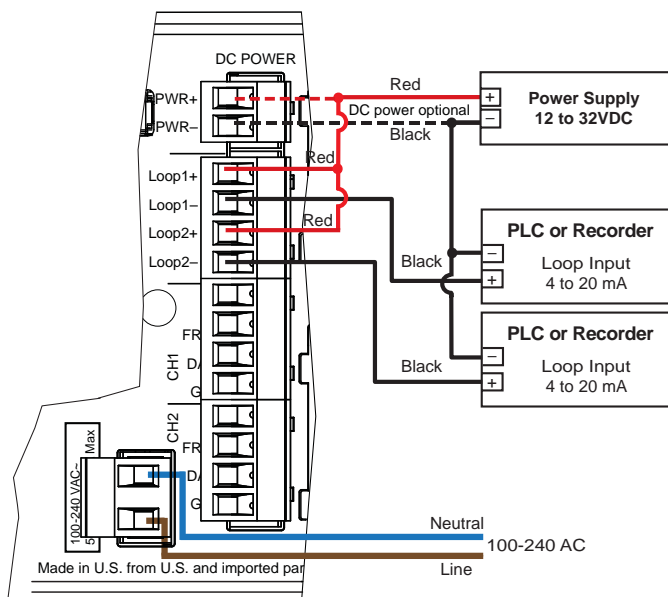

External DC Power is required for the current loops.



### CAUTION

Keep AC power separate from sensor and signal wiring to prevent interference and damage to the 9950 Transmitter.

## Relay Module Wiring

- Terminals accept 12 to 24 AWG wire.
- Strip 10 to 12 mm (0.4 to 0.5 in.) of insulation from wire tips and tin bare ends to eliminate fraying.
- Insert wire tip or ferrule completely into the terminal and secure with the screw.
- Do not allow any AC leads that may be connected to the internal relays to come in contact with low voltage wiring.

### 3-9950.393-1 and 3-9950.393-2

**Relay 1:** The alarm is OFF during normal operation, and will go ON when relay energizes according to 9950 Relay settings.

**Relay 4:** The valve is ON during normal operation, and will go OFF when relay energizes according to 9950 Relay settings.

NO = normally open (closes when energized)  
 NC = normally closed (opens when energized)

Mechanical Relays Rating: 5A 250 VAC, 5A 30 VDC  
 Solid State Relays Rating: 50 mA 30V AC/DC  
 (for 309950.393-2 relay 1 & 2)

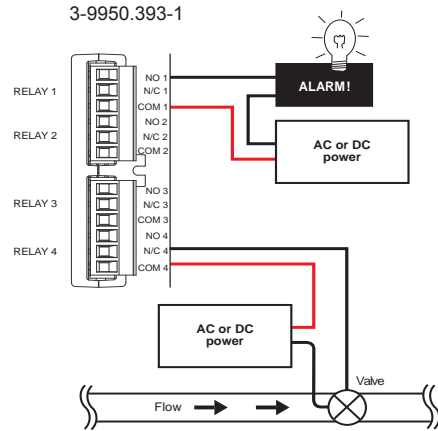

### 3-9950.393-3

The alarm is OFF during normal operation, and will go ON when the relay energizes according to 9950 Relay settings.

Binary input 4 will be ON when the tank level is above the level switch, Binary Input 4 will be OFF when the tank level is below the level switch.

#### Binary Input Ratings

Maximum Input voltage (without damage)	30 VDC
Minimum Input voltage (without damage)	-5 VDC (no operation below 0 VDC)
Maximum input voltage for signal "Off" (low or "0")	1.5 VDC
Minimum input voltage for signal "On" (high or "1")	3.0 VDC
Maximum current draw for signal "0" (low)	≤500 μADC
Minimum current draw for signal "1" (high)	500 μA
Typical current draw for signal "1" (high)	6.0 mA at 30 VDC, 4.8 mA at 24 VDC, 2.4 mA at 12 VDC, 1.0 mA at 5 VDC

#### 3-9950.393-3 Internal Power

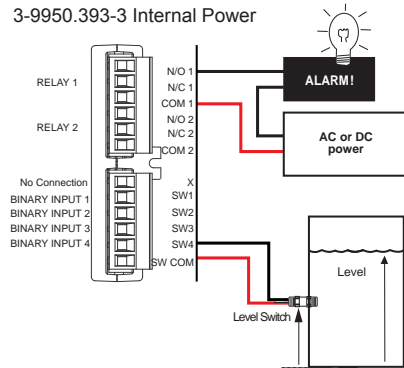

#### 3-9950.393-3 External Power

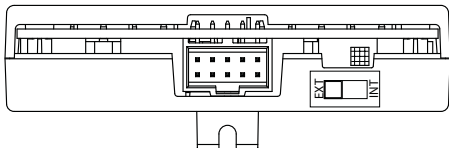
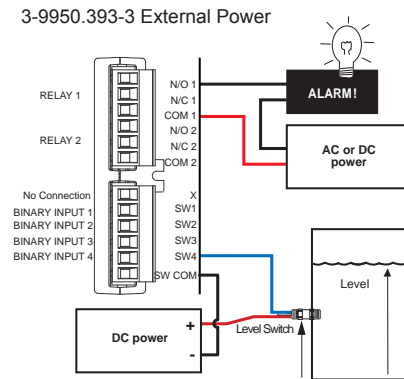

**Power Switch**  
 EXT  
 INT



If an externally powered sensor is connected with the 3-9950.393-3 module, set the power switch to the EXT position. The module can power external sensors by switching the power switch to the INT position. Maximum power that can be drawn from the module is 6mA at 30 VDC.

## Operation

### Keypad Functions

The four buttons of the keypad (▲ ▼ ► ENTER) are used to navigate display modes according to the descriptions in this table. Notice the function of each button may change depending on the display mode.

This menu operation sets up the 9950 for basic function:

1. Select desired language using the [UP] and [DOWN] arrows. Press ENTER to save.
2. Press ► to select the TIME FORMAT. Press ▲ or ▼ to select 24 hour or AM/PM. Press ENTER to save the format selection.
3. Press the ▼ move to the next selection, SET TIME. Press ► to scroll through hours, and minutes place values. Use ▲ or ▼ to adjust the value. Press ENTER to save the time selection.
4. Press ▼ to move to the next selection, SET DATE FORMAT. Press ► to select the MM/DD/YYYY date format and ▼ or ▲ to scroll through other format options. Press ENTER to save the date format selection.
5. Press ▼ to move to the next selection, SET DATE. Press ► to scroll through the days, months, and years. Use ▲ or ▼ to adjust the number, and ► to select the next number. Press ENTER to save the Date selection.
6. Press ▼ to move to the next selection, SET DECIMAL MARK. Press ► and use ▲ or ▼ to highlight desired decimal separator (comma or decimal mark). Press ENTER to save the decimal mark selection.
7. Press ▼ to move to the next selection, SELECT UNITS. Press ► and scroll ▲ or ▼ to choose Metric or U.S. Customary. Press ENTER save unit selection.
8. Press ▼ to move to the next selection SETUP CHANNEL 1. Press ENTER, ('Looking for Sensor Type' will appear on the screen).  
The 9950 will search for an attached S<sup>3</sup>L sensor on Channel 1. The found sensor type will be highlighted. If your desired sensor is not highlighted, use the ▲ or ▼ to scroll through the sensor list and select another sensor type.  
Press ENTER to save sensor type selected.  
Press ▲ or ▼ to access screens to adjust common sensor parameters.  
► = edit, ENTER = Save, ▲+▼ = Cancel.  
Press ▲+▼ to return to SETUP CHANNEL 1 screen.
9. Press ▼ to move to the next selection, SETUP CHANNEL 2. Repeat steps in number 8 to set up Channel 2. Press ▼ to go back to Channel 1, if desired. When done, press ▲+▼ together one time exits to the previous menu. Press ▲+▼ together a second time to exit Easy Start Up.

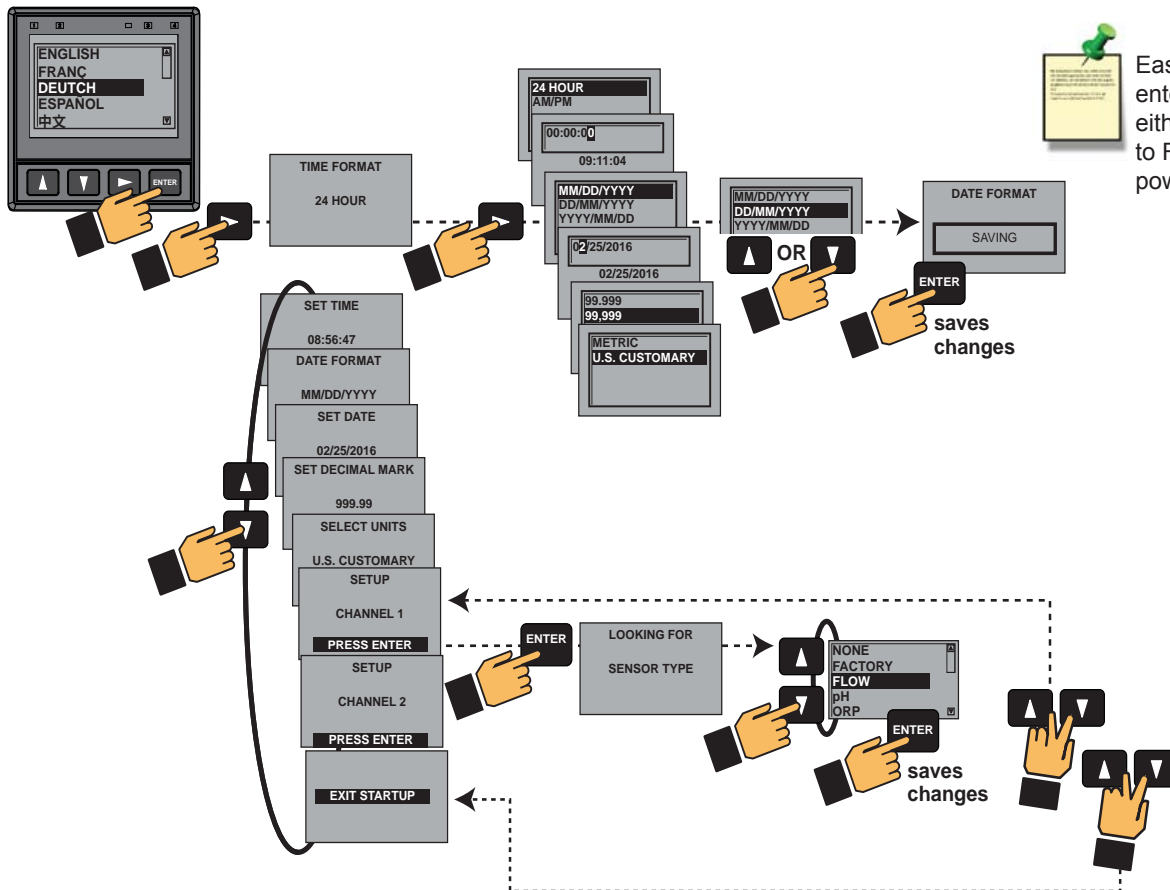

Easy Set Up can be entered by setting either or both channels to Factory and cycling power on the 9950.



## Password

### Password Overview

The password is required to start editing. Once entered correctly, this password will not be needed for subsequent uses, until the menu system is exited. The password will be required when the menu system is re-entered.

Your choice of password (STD or CODE) is selected in the Options Mode.

- **STD**

The standard (STD) password is ▲ ▲ ▲ ▼ , pressed in sequence. This password is designed to protect the 9950 from unintentional changes. It is best suited for systems where a group of people need to be able to change settings.

- **CODE**

The CODE default setting is 0000, adjustable to any 4-digit numerical code up to 9999. Using a personal code provides the maximum degree of security. This code can be modified in the Options mode.

## Operation

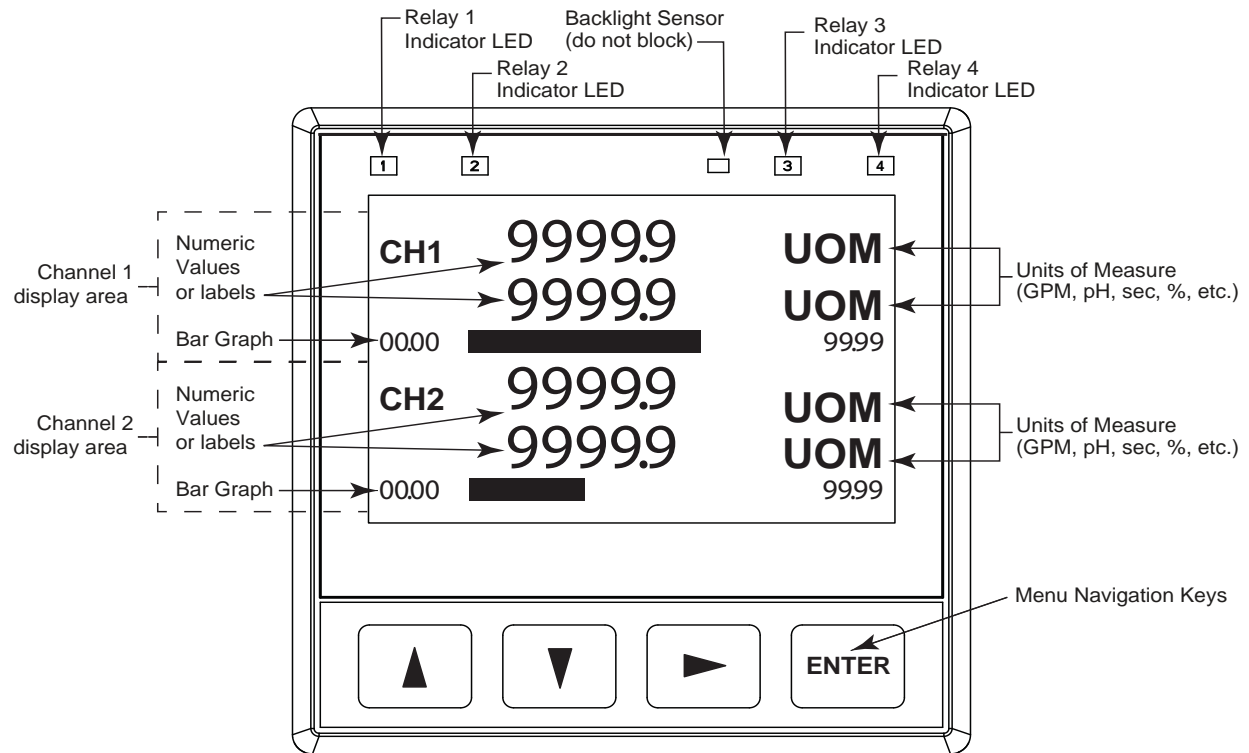

### UP, DOWN keys

Scroll through Menu options or adjust values during editing  
Press both together to exit a menu or escape without saving

### RIGHT key

Select item or character to edit

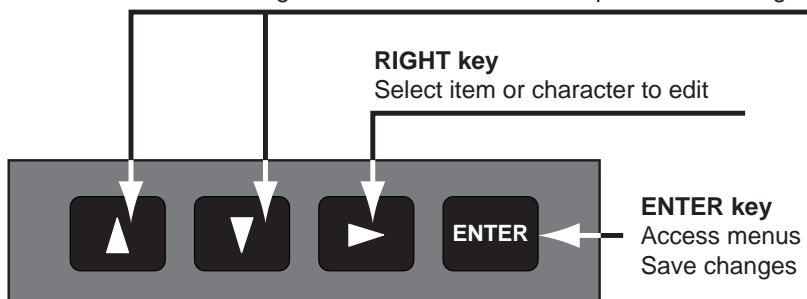

## Warranty Information

Refer to your local Georg Fischer Sales office for the most current warranty statement.

All warranty and non-warranty repairs being returned must include a fully completed Service Form and goods must be returned to your local GF Sales office or distributor.

Product returned without a Service Form may not be warranty replaced or repaired.

Signet products with limited shelf-life (e.g. pH, ORP, chlorine electrodes, calibration solutions; e.g. pH buffers, turbidity standards or other solutions) are warranted out of box but not warranted against any damage, due to process or application failures (e.g. high temperature, chemical poisoning, dry-out) or mishandling (e.g. broken glass, damaged membrane, freezing and/or extreme temperatures).

## Product Registration

Thank you for purchasing the Signet line of Georg Fischer measurement products.

If you would like to register your product(s), you can now register online in one of the following ways:

- Visit our website [www.gfsignet.com](http://www.gfsignet.com). Under **Service and Support** click **Product Registration Form**
- If this is a pdf manual (digital copy), [click here](#)

## Table of Contents

General Information .....	2
Safety Information/Installation.....	2
Terminal Identification .....	3
Wiring .....	4
Sensor Wiring.....	4
Sensor Wiring.....	5
Power Wiring.....	6
Relay Module Wiring.....	7
Operation .....	8
Password .....	9
Keypad Operation .....	9
Signal Type: 4 to 20 mA.....	10
Warranty Information.....	10
Product Registration .....	10
Table of Contents .....	10
Dimensions .....	11
Module Installation .....	11
Plug-In Modules .....	12
Relay Modules .....	12
Signal Type: Frequency .....	13
Signal Type: Digital (S <sup>3</sup> L) .....	13
Signal Type: 4 to 20 mA.....	14
Relay Functions .....	14
Relay Modes .....	15
Derived Functions .....	19
Menu System .....	20
Common Menu .....	21
Loop Menus .....	21
Relay Menu.....	22
Option Menu.....	24
View Mode .....	26
Sensor-Specific Menus .....	28
Flow.....	28
pH.....	30
ORP.....	32
Conductivity/Resistivity .....	34
Pressure .....	36
Level/Volume.....	38
Temperature .....	41
4 to 20 mA.....	42
Salinity.....	44
Dissolved Oxygen .....	46
Field Software Update .....	48
Updating the 9950.....	48
Troubleshooting .....	49
Appendix .....	51
Averaging .....	51
LOG Current Loop Output .....	51
Custom Measurements.....	52
Calibration Procedures - pH.....	56
Calibration Procedure - ORP .....	58
Calibration Procedure - Conductivity/Resistivity.....	60
Calibration Procedure - Flow .....	61
Calibration Error Messages .....	62
USP Limits.....	63
Maintenance.....	63
Map of 9950 Relay and Loop Sources .....	64
Specifications .....	65
Ordering Information .....	68

## Dimensions

3-9950-1/-2

### Front View

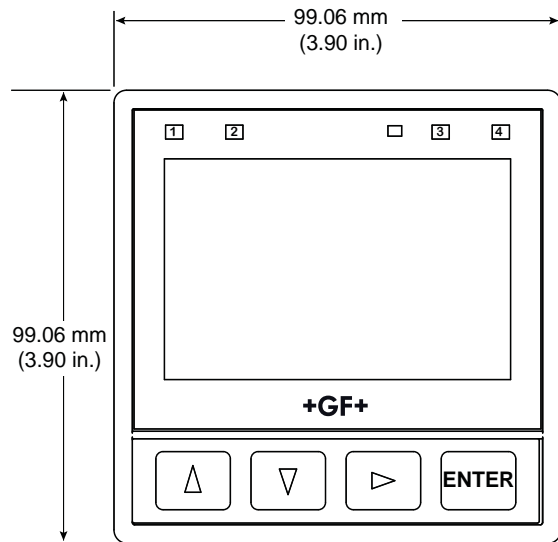

### Side View

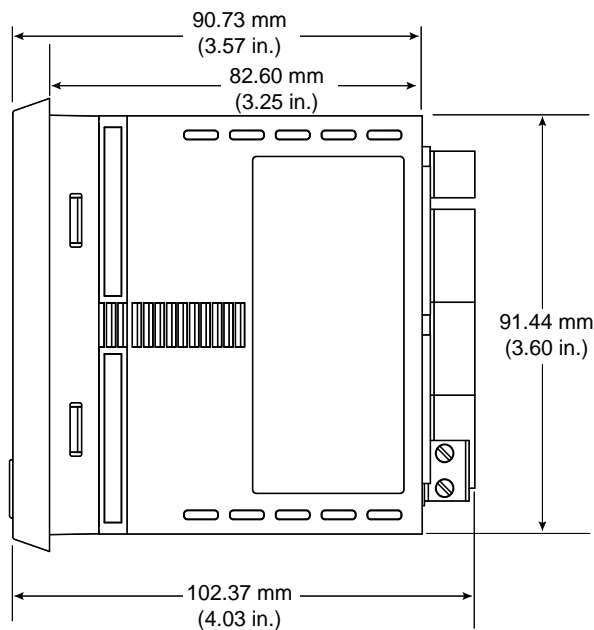

## Module Installation

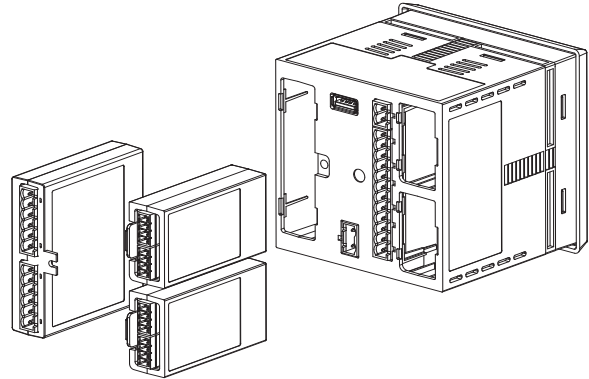

### CAUTION

Avoid Electrostatic Discharge (ESD).

The plug-in modules may be installed either before or after the base unit is mounted. If the 9950 Base Unit will be mounted using the provided quick clip mounting bracket. Install plug-in modules first with power disconnected.



### CAUTION

Exercise care when installing modules. Do not bend connecting pins.

### To install modules:

Remove power from the 9950. Carefully align pins and connectors (do not bend connecting pins) and push module firmly into place, then attach with screw(s)

### To remove modules:

Remove power from the 9950.

### For Relay Modules:

Unplug connectors, remove screw(s), and carefully pull module straight out from the base unit. Do not bend the connecting pins.



### WARNING

Relays may be connected to external high-voltage power sources or multiple power sources creating an electrocution hazard.

## Plug-In Modules

Optional modules and accessories are available for the 9950:

- a. Base Unit (required)
- b. Slot for optional Relay Module
- c. Slot for optional Module 1
- d. Slot for optional Module 2

Each item is ordered separately. Modules are field-replaceable at any time.

See Module Installation (pg. 11) and Ordering Information (pg. 68) sections for more details.

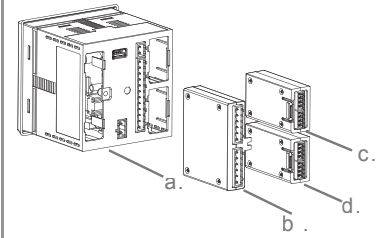

### CAUTION

Avoid Electrostatic Discharge (ESD).



- Minimize handling of the plug-in modules to reduce the possibility of damage due to ESD.
- Handle modules by the edges. Never touch any exposed circuitry or contacts.



- Wear an anti-static wristband or stand on an anti-static mat, or keep one hand touching a properly grounded pipe or other piece of properly grounded metal when handling modules.

## Relay Modules

Mfr. Part No.	Code	Description
3-9950.393-1	159 310 268	Relay Module - 4 Mechanical Relays
3-9950.393-2	159 310 269	Relay Module - 2 Mechanical Relays, 2 Solid State Relays
3-9950.393-3	159 310 270	Relay Module - 2 Mechanical Relays , 4 Binary Inputs

The 9950 has a slot for an optional Relay Module for any of the modules listed above.

- Dry-contact relays are electromechanical switches with a moving contact armature. They are suitable for many general-purpose applications, AC or DC, including AC loads up to 250 V.
- Solid-state relays are electronic switches with no moving parts. They may be used with AC or DC loads, but have lower current handling capability and voltage ratings than Dry-contact relays. Solid-state relays will outlast Dry-contact relays in pulsing applications. 30 VDC/ VAC maximum.
- The four Binary Inputs can detect if an external sensor or switch is open or closed. The switch state can be used to control the relays in the module. The four binary inputs only control relay activation and are not considered an input measurement.

For wiring information, refer to the Relay Wiring section, page 7.



The 3-9950.393-3 module can be set to supply power to the external switch/sensor. For switches/sensors that require power set the Int/Ext switch to the Int positions. If the external Switches/Sensors are powered set the Int/Ext switch to Ext. Important for externally powered switches/sensors ensure the output signal is within the allowable range for the 3-9950.393-3.

### NOTE:

- The four red Indicator LEDs on the front panel of the 9950 show the status of relays 1, 2, 3, & 4. The LEDs will activate with or without a relay module installed.
- Hysteresis and time delay are adjustable for each relay.

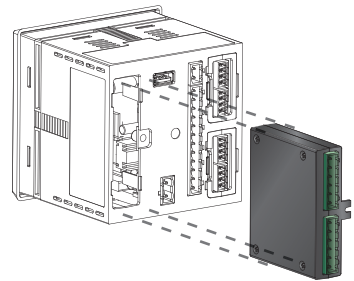

3-9950.393-3

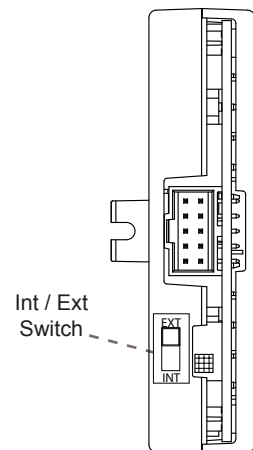

### CAUTION

Keep relay wiring separate from sensor and signal wiring to prevent interference and damage to the 9950 Transmitter.

### CAUTION

Switching active loads (usually inductive) can cause contact arcing sufficient to damage the relays.



The RC Filter Kit or “snubber” (part number 3-8050.396) is available as an accessory to reduce or eliminate these damaging effects. Recommended for inductive loads greater than 50 VAC (remote relays, solenoids, pumps, etc.)

## Signal Type: Frequency

Signet flow sensors 515/8510, 525, 2000, 2100, 2507, 2536/8512 and 2540 provide a frequency output. (Flow sensors 2537, 2551 and 2552 can be configured with either Digital (S<sup>3</sup>L) or Frequency outputs).

The maximum allowable cable length for sensors with frequency output is dependent upon the output signal strength of the sensors themselves, and the degree to which the signals are susceptible to EMI or "noise." This is largely a function of whether the sensors are self-powered (515/8510 and 525), or powered by an external source.

- The input terminals on the 9950 carry frequency data signals from the sensor.
- The 9950 has a selection for 515/525 under the input menu. Select "Yes" for optimum signal performance.
- Do not route sensor or output cables in conduit containing AC power wiring. Electrical noise may interfere with sensor signal.
- Routing cable in grounded metal conduit will help prevent electrical noise and mechanical damage.
- Seal cable entry points to prevent moisture damage.
- Only one wire should be inserted into a terminal. Splice double wires outside the terminal.
- In case of noise interference, ground the sensor SHIELD wire to a local earth ground at a point near the sensor.
- Consult the sensor manual for additional wiring information.

## Signal Type: Digital (S<sup>3</sup>L)

- The input terminals on the 9950 carry Digital (S<sup>3</sup>L) serial data from the sensor.
- Do not route sensor or output cables in conduit containing AC power wiring. Electrical noise may interfere with sensor signal.
- Routing cable in grounded metal conduit will help prevent electrical noise and mechanical damage.
- Seal cable entry points to prevent moisture damage.
- Only one wire should be inserted into a terminal. Splice double wires outside the terminal.
- The TOTAL cable length from I/O devices to the transmitter must not exceed 305 m (1000 ft).
- In case of noise interference, ground the sensor SHIELD wire to a local earth ground at a point near the sensor.
- Consult the sensor manual for additional wiring information.
- The maximum cable length of the Digital (S<sup>3</sup>L) bus varies depending on the types of sensors connected and the size of the conductors in the cable. For best results, determine the maximum cable length for the system before routing cables.

Flow sensor models with Frequency Output	Maximum Cable Length	
	60 m (200 ft)	305 m (1000 ft)
515/8510	X	
525	X	
2000		X
2100		X
2507		X
2536/8512		X
2537		X
2540		X
2551		X
2552		X



In case of noise interference, connect the cable shield to earth ground.

### Maximum total cable length of the Digital (S<sup>3</sup>L) Bus:

The quality of the cable used in the bus determines the maximum length. The maximum cable length may not exceed 305 m (1000 ft), regardless of current requirements.

## Signal Type: 4 to 20 mA

When connecting a non-Signet sensor to the 9950, the sensor's 4 to 20 mA signal must be converted to Digital (S<sup>3</sup>L). The 8058 i-Go Signal Converter accepts any 4 to 20 mA signal and converts it into Digital (S<sup>3</sup>L).

1. Wire the 8058 between the 4 to 20 mA loop source and the 9950 Digital (S<sup>3</sup>L) input terminals.
2. In the 9950 INPUT menu, sensor TYPE screen, select the '4 to 20 INPUT' sensor (see System Setup Menu discussion, page 8).

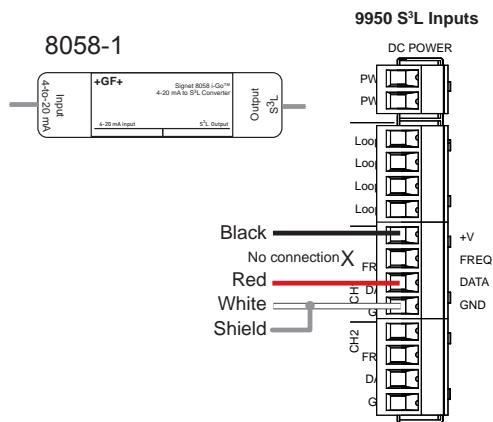

## Relay Functions

Set your relay functions to your own application requirements.

Once a setting is saved it becomes immediately active.

1. Press and hold ENTER for 3 seconds
2. Go to the Relay Menu by pressing ▼ ▼ then ENTER.
3. Press the ► to select desired source. You will be asked to enter a code or password. Select source and press ENTER to confirm.
4. Press ▼ to enter the relay **MODE** selection screen.
5. Press ► and then ▼ to select **R1 MODE LOW**. Press ENTER to confirm.
6. Press ▼ to **R1 SET LOW**. Press ► to enter GPM value of 5.5.
7. Use the ▲ and ▼ to change Set Point. Press ENTER to save.
8. Scroll ▼ to the **R1 HYSTERESIS** menu.
9. Press ► to edit.
10. Set the hysteresis for this relay. Set the value to **2.5 gpm**.
11. Press ENTER.
12. Scroll down ▼ to the **R1 ON DELAY** menu.
13. Press ► to edit.
14. Set the turn-on delay in seconds for the relay: **15.0**.
15. Press ENTER Then (▲▼) (▲▼)
16. Exit to View Mode.

- Relay function can be tested in the RELAY menu.



Example: Set a relay R1 to turn on at a low setpoint of 5.5 gpm with a time delay of 15 seconds and turn off at 8.0 gpm.

Remember,  
 SET LOW + hysteresis = OFF  
 Relay 1 Source = CH1 Primary  
 Relay 1 Mode = Low  
 R1 Set Low = 5.5  
 R1 Hysteresis = 2.50  
 R1 on delay = 15.0 sec

## Relay Modes

The 9950 relays are selectable and configurable and can be used as switches that respond when the process value moves above or below a user-defined setpoint or it can be used to generate a pulse at a rate proportional to the process value. They can be used for Low Alarm, High Alarm or Proportional Pulse triggering related to the process value. All relay functions are set up in the RELAY menus.

- ◇ Relay energized
- ◆ Relay de-energized

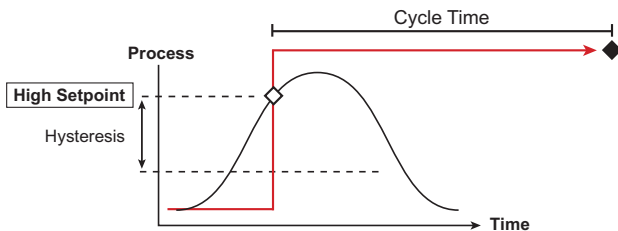
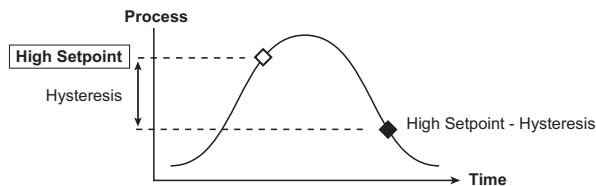
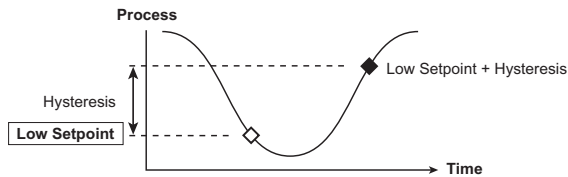

- ◇ Relay energized
- ◆ Relay de-energized



### CAUTION!

If power is lost to the 9950 Transmitter during a cycle, the Cycle Time will reset. If the condition still exists after power is restored, the relay will be energized for the complete Cycle Time.

Generation II, or greater, supports the ability to activate the Red Backlight when a relay is activated. An optional check box is displayed during the programming of a relay that will turn the Red Backlight on when the relay is activated. The Red Backlight can be activated by any relay or relay mode. Generation II, or greater, English, French, German, or Spanish Languages only. The relays can have a custom label assigned for easy of identification.

#### ◇ Low Setpoint:

Relay is on when the measured value is less than or equal to the setpoint. Relay turns off when the measured value is equal to or greater than the Low Setpoint + Hysteresis

#### ◇ High Setpoint:

Relay is on when the measured value is greater than or equal to the setpoint. The relay turns off when the measured value is less than or equal to the High Setpoint - Hysteresis.

#### ┌ Cycle High/Low:

The relay will energize for a set length of time after the process value goes above (or below) the setpoint. The relay will stay on for the CYCLE TIME and then turn off, even if the process value is still above (or below) the setpoint. The cycle will not repeat until the cycle time completes and either the process value goes below the set point minus the hysteresis for Cycle High or goes above the setpoint plus the hysteresis for Cycle Low.

In FLOW, Cycle High activates the relay each time the volume reaches the SET VOLUME setpoint (see page 23).

**NOTE:** To reset the timer (or volume in Flow): in the RELAY menu, select TEST RELAY function. The timer will reset to 0 if the condition no longer exists when the TEST is performed. The timer will restart if the condition still exists.

## Relay Modes

### ◆ Window In/Out:

Relay is on when the value is equal to or higher or lower than the high or low setpoint.

WINDow IN = relay on if measurement is inside the window of two setpoints.

WINDow OUT = relay on if measurement is outside the window of two setpoints.

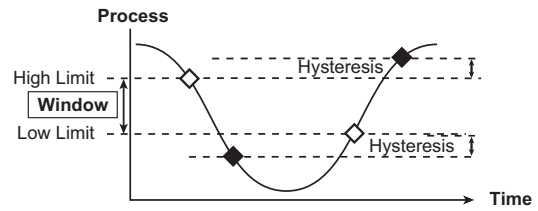

Window IN example

- ◇ Relay energized
- ◆ Relay de-energized

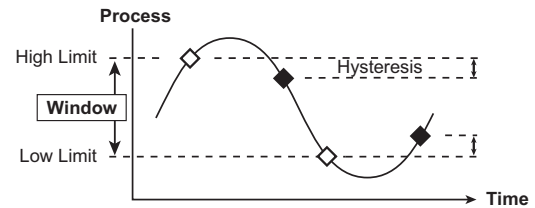

Window OUT example

### ▭▭ Proportional Pulse Operation:

The transmitter can output a pulse at the rate defined by the settings in the CAL menu and the sensor input. The maximum pulse output is 300 pulses per minute.

Example usage would be to control solenoid-operated dosing pumps.

For example: As the process value rises above the setpoint, the output will start pulsing in relation to the process value, the maximum pulse endpoint and the programmed pulses/minute. The pulse rate will change as the process value changes and approaches the programmed endpoint. This functionality can be used to precisely control the process.

The starting point, endpoint and maximum pulse rate are selectable in the RELAY menus.

**NOTE:** Relay LEDs will flash in PULSE mode.

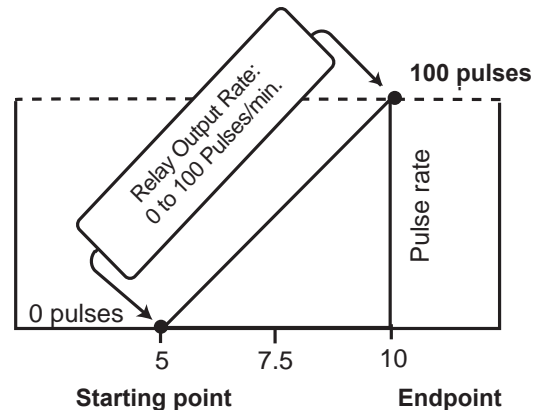

In the example:

- The output will be 0 pulses/min. when value is less than 5.
- The output will be 50 pulses/min. when value is 7.5.
- The output will be 100 pulses/min. when value is 10 or greater.



## Relay Modes

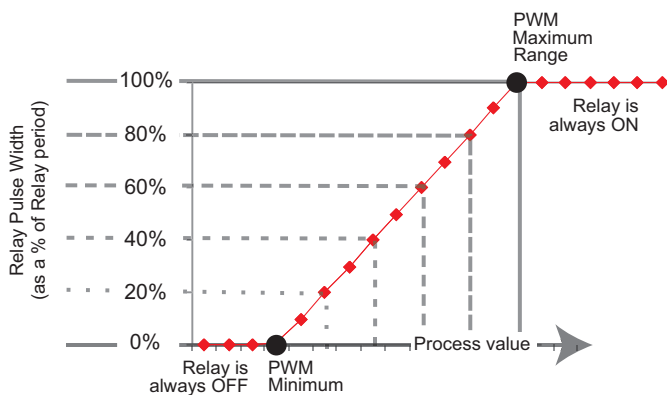

### Note

- The pulse width will be 100% of the relay period (relay always ON) when the process value is greater than the maximum range.

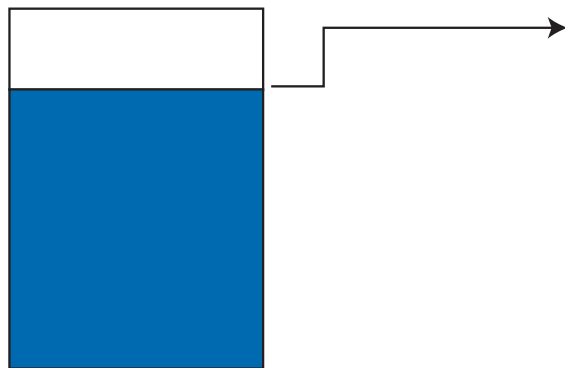
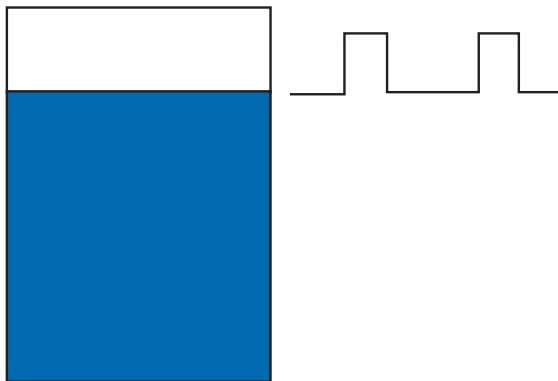

### • Pulse Width Modulation

PWM automatically varies the ratio of ON time to OFF time proportional to minimum and maximum range settings.

The relay period is the sum of the time a relay is ON and the time it is OFF.

Relay pulse width is the time the relay is ON.

The 9950 must be programmed with the relay period, and with the low and high setpoints.

**NOTE:** The PWM mode is not used for Pressure applications.

**NOTE:** Relay LEDs will flash in PWM mode.

### Example:

- The pulse width will be 0% of the relay period (relay always OFF) when the process value is less than the minimum range.
- The pulse width will be 100% of the relay period (relay always ON) when the process value is greater than the maximum range.
- The pulse width will be 60% of the relay period when the process value is at 60% of the span between the minimum and maximum range.

### • Volumetric Pulse

The relay will activate for the set pulse width once the specific volume of fluid is registered. Flow Inputs only.

**NOTE:** Relay LEDs will turn on when the relay is active

### • Totalizer Volume

Relay activates and latches when a specified volume of fluid is registered on the resettable totalizer. For Flow inputs only.

Total Volume mode counts the TOTALIZER Units until the setpoint volume is reached, then turns on the relay until the resettable totalizer is reset.

If the Resettable Totalizer reading is greater than the setpoint, the relay will be turned on immediately. The relay will be off when the totalizer is below the set point or the resettable totalizer is reset to zero.

This mode is useful to trigger a reminder when a process is due, as for a backwash cycle or filter change.

## Relay Modes

### • Multiple

When a Relay Source is set to "MULTIPLE," the mode presents four Boolean logic formulae called "Relay Operators." Each Operator can be programmed with up to three different conditions. The relay will only be activated when the complete formula is satisfied.

### Boolean Relay Logic Operations

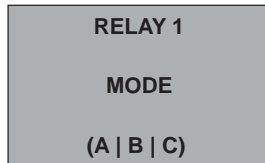

$(A | B | C)$  means  
"Activate this relay when any condition (A, B, or C) is true."

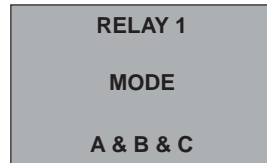

$(A \& B \& C)$  means  
"Activate this relay only when all conditions (A, B, and C) are true."

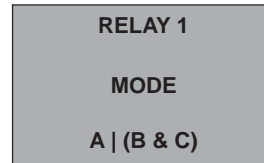

$(A | (B \& C))$  means  
"Activate this relay if A is true OR if B AND C are both true."

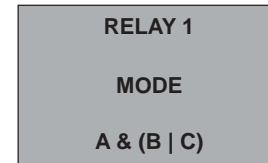

$(A \& (B | C))$  means  
"Activate this relay only if A is true AND either B or C are also true."

**Example:** Set Relay 1 Mode to  $A | B | C$ . "This relay will activate IF channel 1 pH falls below 6, OR if channel 2 pH rises above 7.8, OR if binary input 1 is active (On or Closed). Relay #1 will activate 30 seconds after any one the conditions are met"

Condition A: The pH on Channel 1 is less than 6.

Condition B: The pH on Channel 2 is greater than 7.8

Condition C: Binary Input 1 is On.

On Delay: 30

When operating properly, all three of these conditions are FALSE. If any one of them becomes TRUE, then Relay 1 will be activated.

Relay 1 will remain activated until the TRUE condition becomes FALSE again, including the hysteresis band.

### • Binary

When the relay source is set to "Binary." The Binary Inputs can sense if the input is ON (Closed) or OFF (Open). The four binary inputs only control relay activation and are not considered a measurement source. Each binary mode is independent and each of them can be assigned to a relay mode.

### • Timer

When the "Timer" relay source is selected, the time can be selected using Period or Weekday modes. Both relay modes work directly with the time settings and formats that are entered at start up or adjusted in the options menu. The relay is normally open until the specified time is reached, at which time the relay is closed, triggering the relay for a specified duration. The "Hold while" feature allows the user to hold the measurement from a channel input 1, 2, or both, or none for a specified recovery time. The 9950 will deactivate held relays and hold the 4 to 20 mA at previous value.

- Period Mode lets the user set a periodic interval, in days, hours or minutes, at which the relay will activate. A First Start screen lets the user set the day and time for the Period Mode to begin.
- Weekday Mode lets the user specify the days of the week, Sunday, Monday, Tuesday, Wednesday, etc., at which the relay will activate. A Start Time screen lets the user set the time of day for the weekday activation. Weekday Mode does not have a Start Delay parameter.

### Example

A 2282 Guided Float Switch is mounted in a tank. The output of the Float Switch will prevent a relay from activation if the tank is below the position of the Float Switch.

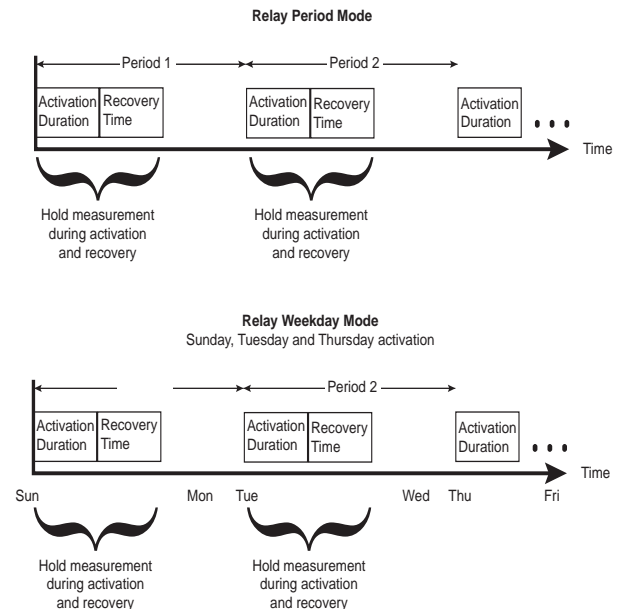

### Caution:

If HOLD WHILE RELAY # ACTIVE setting is changed while an Activation or Recovery is in process, the setting will be applied after the cycle is complete. To apply the change immediately, cycle power to the 9950.

## Derived Functions

When two of the same type of measurement are present, the 9950 can calculate several derived functions from like pairs of measurements.

Up to four derived Functions can be defined and used as the source for display and output functions.

- Flow, Temperature, Pressure, Conductivity and Level channels must have matching units. (Flow channels must also have same time base).
- Conductivity channels will automatically scale to  $\mu\text{S}/\text{cm}$  before the function calculation is made.
- **Three types of derived measurements can be applied to any set of sensors, regardless of type.**
  - Ratio: Measurement 1  $\div$  Measurement 2 or Measurement 2  $\div$  Measurement 1
  - Delta (Difference): Measurement 1 - Measurement 2 or Measurement 2 - Measurement 1
  - Sum: Measurement 1 + Measurement 2
- Custom labels can be assigned to Derived Functions for ease of identification

### % Passage and % Reject

- % Passage and % Reject are derived functions based on conductivity measurements only, specifically for use in reverse osmosis systems.
- % Passage is the amount of contaminates remaining in the product water compared to the level of contaminates in the feed water. For example, if the feed water measures  $375 \mu\text{S}$  and the product water measures  $18.75 \mu\text{S}$ , the % Passage is  $(18.75/375) \times 100 = 5\%$ .
- % Reject is the amount of contaminates rejected to the concentrate water compared to the amount of contaminates in the feed water. For example, if the feed water measures  $375 \mu\text{S}$  and the product water measures  $18.75 \mu\text{S}$  the % reject is  $[1 - (18.75/375)] \times 100 = 95\%$
- Decreasing Reject values and increasing Passage values usually indicate a problem with the RO membrane.

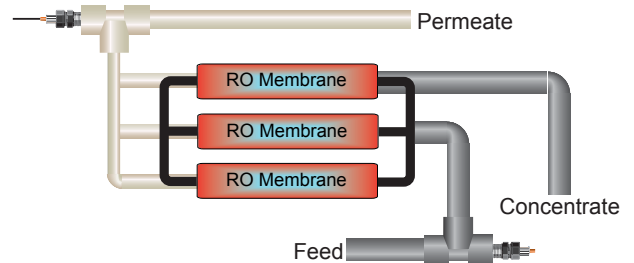

**% Passage:**  $(\text{Permeate} \div \text{Feed}) \times 100$

**% Reject:**  $[1 - (\text{Permeate} \div \text{Feed})] \times 100$

### % Recovery

- % Recovery is a derived function based on flow rate, in a reverse osmosis system.
- To measure % Recovery, the 9950 must have two flow sensors connected. They may be located in the Feed line, the Concentrate line or the Permeate line.
- The 9950 provides 3 different methods for calculating Recovery to accommodate any configuration.
- Both flow sensors must use the same time base and units of measure.

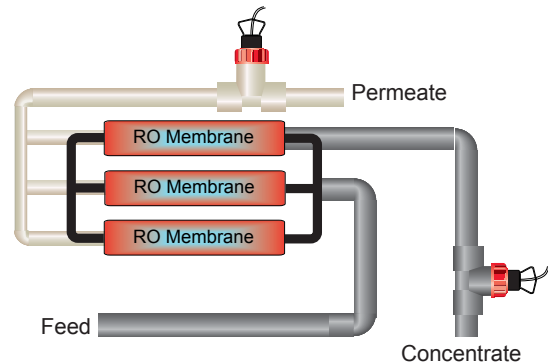

**% Recovery B:**  $\text{Permeate} \div (\text{Permeate} + \text{Concentrate}) \times 100$

In the Setup menu, select the option that states

**% Recovery B, PERMEATE: CONC**

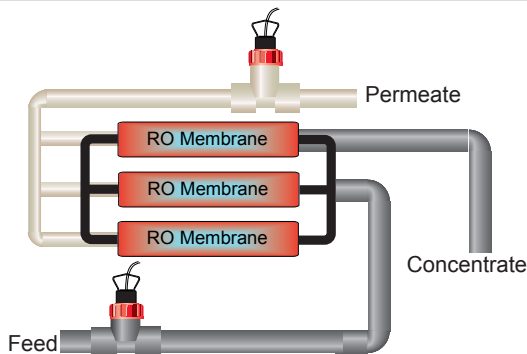

**% Recovery A:**  $(\text{Permeate} \div \text{Feed}) \times 100$

In the Setup menu, select the option that states **% Recovery A, FEED: PERMEATE**

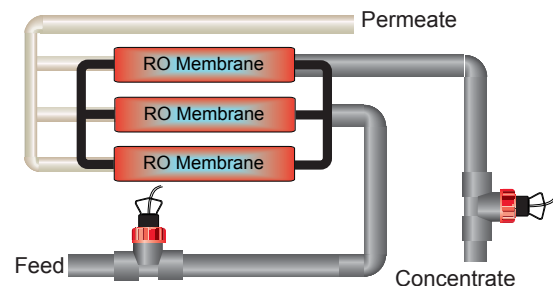

**% Recovery C:**  $[(\text{Feed} - \text{Concentrate}) \div \text{Feed}] \times 100$

In the Setup menu, select the option that states **% Recovery C, FEED: CONC**

## Menu System

### VIEW Mode Overview

The top level of screens are referred to as the **VIEW Mode**. This view displays measurement values as well as current outputs, derived function values, and relay status. The horizontal bar graph represents the primary measurement value that is also displayed in the numeric field above the bar graph. The bar graph is primarily used to display the full scale range of the sensor, but can be scaled via the **OPTION** menu item.

During normal operation, the 9950 displays the **VIEW mode**.

- To select a display, press the ▲ or ▼ arrow keys.  
The display selections scroll in a continuous loop.
- Changing the display selection does not interrupt system operations.
- No password is necessary to change display selection.
- Output settings cannot be edited from the View Mode.
- The display will return to the **VIEW mode** if no button is pressed for 10 minutes.

### MENU Mode Overview

The **MENU mode** enables the user to view and configure all menu items. The five menus available are: **CAL**, **INPUT**, **LOOP**, **RELAY**, and **OPTION**.

**MENU Mode** is entered by pressing and holding **ENTER** for three seconds.

To select a menu use the ▲ and ▼ arrow keys to highlight the desired menu and press **ENTER** to select the menu.

In the selected menu, use the ▲ and ▼ keys to navigate through the menu. Use the ▲, ▼ and ► keys to edit the selected item (see **Menu Navigation** discussion, page 24).

To save the new selection, press the **ENTER** key. A message displaying “Saving” will be displayed for 3 seconds. After this message is displayed, the newly selected value will be displayed, if applicable. To abandon the changes press the ▲ and ▼ arrows simultaneously.

### Password Overview

The password is often required to start editing. Once entered correctly, this password will not be needed for subsequent edits, until the menu system is exited. The password is required when the menu system is re-entered.

Your choice of password (**STD** or **CODE**) is selected in the **Options Menu**

#### • **STD**

The standard (**STD**) password is ▲▲▲▼, pressed in sequence. This password is designed to protect the 9950 from unintentional changes. It is best suited for systems where a group of people need to be able to change settings.

#### • **CODE**

The **CODE** default setting is 0000, adjustable to any 4-digit numerical code up to 9999. Using a personal code provides the maximum degree of security. This code can be modified in the **Options menu**.

### Password Reset

Turn off 9950. Press and hold all 4 keys on keypad while turning on 9950 and unit will revert back to **STD** password.

### Error Handling

Errors occurring while on the measurement screens show a specific message (e.g., **Wrong Sensor**). This message will flash and stays on for 3 seconds and flash off. Once the error is resolved or cleared, the error message stops.

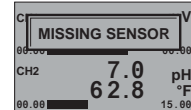

### Scrolling

In some cases, more than one message or measurement may need to be displayed. This is accomplished by alternating the message portions across the screen.

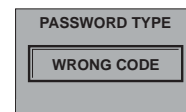

In the **MENU mode**, if the wrong code or password is entered, an **ERROR** message is displayed.

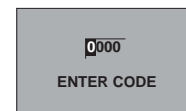

To change your **CODE**, go to **OPTIONS** mode, enter your desired code and press **ENTER**. (The **STD** password cannot be changed.)

## Common Menus

### Common Menus

The menu system shares certain modes between sensor types.  
The following describes the menus found in common between most sensor types.



#### NOTE:

Menu and Mode displays shown are examples only.  
Your displays may vary.

### INPUT Menu



(ALL) Manually select Sensor Type (See page 8 for further instruction).  
Allows user to reset 9950 Transmitter to Factory settings. Allows user to configure sensor specific parameters.  
Note: User is strongly discouraged from changing the sensor type away from the correct sensor.

### LOOP Menu

*The following can individually be set for each loop on the 9950*

<b>LOOP 1</b> <b>SOURCE</b> <b>CH SECONDARY</b>	Select source for each loop. Choose CH 1 PRIMARY, CH 1 SECONDARY, CH 2 PRIMARY, CH 2 SECONDARY, or DERIVED FUNCTION 1 - 4. Secondary Values are only available for pH, Conductivity/Resistivity, Level, Salinity, and Dissolved Oxygen. Derived Functions are only available for configured Derived Functions
<b>LOOP 1</b> <b>LABEL</b> <b>LOOP 1</b>	English, French, German, and Spanish languages only. A custom label can be assigned to the loop for ease of identification.
<b>LOOP 1</b> <b>MODE</b> <b>LOG</b>	(COND/RES only) Select LIN/LOG. Default = LIN. See LOG Current LOOP Output discussion in Appendix.
<b>L1 4 mA SETPOINT</b> <b>0.00</b> <b>UNITS</b>	(ALL) Set value corresponding to desired 4 mA output. 6 digits max. Default = 0 (ORP = -999).
<b>L1 20 mA SETPOINT</b> <b>100.00</b> <b>UNITS</b>	(ALL) (Not shown in COND/RES LOG Mode) Set value corresponding to desired 20 mA output. 6 digits max. Defaults = 100 (Flow, Cond/Res, Temp), 14 (pH), 1000 (ORP), 10 (Lvl/Prs), 5 (4 to 20 mA), 80 (Sal).
<b>LOOP 1</b> <b>ERROR VALUE</b> <b>22 mA</b>	(ALL) Set desired LOOP output value when sensor error (e.g., bad sensor, broken wire) is detected. Select (3.6 mA, 22 mA, or NONE). Default = 22.
<b>L1 ADJUST 4 mA</b> <b>4.00</b> <b>mA</b>	(ALL) Allows fine-tuning to compensate for errors in other equipment connected to the 9950. Adjust the current output at 4 mA. The display value represents the precise current output. Adjustment limits: from 3.80 mA minimum to 5.00 mA maximum. Default = 4.00 mA.
<b>L1 ADJUST 20 mA</b> <b>21.0</b> <b>mA</b>	(ALL) Allows fine-tuning to compensate for errors in other equipment connected to the 9900. Adjust the current output at 20 mA. The display value represents the precise current output. Adjustment limits: from 19.00 mA minimum to 21.00 mA maximum. Default = 20 mA.
<b>L1 TEST LOOP</b> <b>12.05</b> <b>mA</b>	(ALL) Press ▲ or ▼ to manually control the output current value from 3.8 mA to 21.00 mA to test the output of LOOP. The current loop will revert to automatic control when this menu item is left.

## Common Menus

### RELAY Menu

RELAY 1 SOURCE CH 1 PRIMARY	All relays select source for each Relay 1 - 4. Choose CH 1 PRIMARY, CH 1 SECONDARY, CH 2 PRIMARY, CH 2 SECONDARY, BINARY 1 - 4, DERIVED FUNCTION 1 - 4, TIMER, or MULTIPLE. Secondary Values are only available for pH, Conductivity/Resistivity, Level, Salinity and Dissolved Oxygen. Derived Functions are only available for configured Derived Functions
RELAY 1 MODE BINARY ON	(All Binary) Binary Inputs can set to be active when On (Closed) or Off (Open). Requires the 3-9950.393-3 module for use.
RELAY 1 SOURCE TIMER	(TIMER) Allows the user to select either Period or Weekday Modes
RELAY 1 04/23/2016 START DATE	TIMER in PERIOD mode will allow the user to select a unit of time, a quantity of time, a specific start date, a specific start time, a duration, and a HOLD feature. Default HOURS, 2, 12/01/2015, 10:00, 60 secs, HOLD WHILE RELAY # ACTIVE NO
RELAY 4 <input checked="" type="checkbox"/> SUN <input type="checkbox"/> MON <input checked="" type="checkbox"/> TUE <input type="checkbox"/> WED <input checked="" type="checkbox"/> THU <input type="checkbox"/> FRI <input checked="" type="checkbox"/> SAT	TIMER in WEEKDAY mode will allow the user to select a day or multiple days of the week with a START TIME, DURATION, and a HOLD feature. Default 10:00, 60 secs, HOLD WHILE RELAY # ACTIVE NO
RELAY 1 SOURCE MULTIPLE	MULTIPLE will use up to 3 sources where the relay will only be activated if these sources meet specified conditions A B C, A&B&C, A (B&C), A&(B C) Default is OFF Refer to pg 18.
RELAY 1 MODE A   B   C	MULTIPLE MODE A B C will activate if any condition A, B, or C is true.
RELAY 1 MODE A & B & C	MULTIPLE MODE A & B & C will activate if all conditions A, B, and C are true.
RELAY 1 MODE A   (B & C)	MULTIPLE MODE A (B & C) will activate if A is true or if B and C are true.
RELAY 1 MODE A & (B   C)	MULTIPLE MODE A (B   C) will activate if A is true or if B and C are true.
RELAY 1 MODE OFF	(ALL) Select the desired mode of operation for the (R1) output (OFF, LOW, HIGH, WINDow IN, WINDow OUT, CYC LOW (except FLOW), CYC HIGH, PROP PuLSe, VOL PuLSe, PWM, TOTAL, USP, ERROR mode) (See page 15, Relay Modes). Default = OFF. Continue stepping through to select R2, R3 and R4 output modes. When MODE is set to ERROR, relay energizes if sensor problem is detected on either channel. ON DELAY delays the energizing of the relay until after the programmed delay time. (See Cycle High/Low discussion on page 15).
RELAY 1 LABEL RELAY 1	English, French, German, and Spanish only. A custom label can be assigned to the relay for ease of identification
R1 SET LOW 0.00 UNITS	(ALL) (Shown if LOW, WIND IN/OUT or CYC LOW mode) Relay turns on if process measurement is equal to or lower than this value. Set desired value.

## Common Menus

### RELAY Menu

<b>R1 SET HIGH</b> 100.0 UNITS	(ALL) (Shown if HIGH, CYCLE HIGH (all except Flow) or WIND IN/OUT mode) Relay energizes if process measurement is equal to or higher than this value. Set desired value.
<b>R1 SET VOLUME</b> 100.00 UNITS	(FLOW only) (Shown if Cycle High (Flow), TOTAL or VOL PLS mode) Amount of accumulated flow that must be counted before a pulse is sent out. Relay energizes if flow volume exceeds this value. Set desired value.
<b>R1 HYSTERSIS</b> 0.50 UNITS	(ALL) (Shown if LOW, HIGH, WIND IN/OUT, CYC LOW/HIGH or USP mode) Hysteresis prevents the system from chattering around the set point. Set amount (in units of measure from INPUT Mode) to add to SET LOW or SET HIGH values.
<b>R1 USP PERCENT</b> 0.20 %	(COND/RES only) (Shown only in USP mode) Relay energizes if USP value drifts by this value away from USP limit. (See USP Limits discussion in the appendix, page 62). <b>NOTE:</b> Relay will activate if USP limit is exceeded, Temperature Comp is set to Linear or Pure Water, Conductivity Measurement is NOT in uS, or if the Conductivity is reporting a measurement error.
<b>R1 ON DELAY</b> 5.0 SEC	(ALL) (Shown if Low, High, WIND IN/OUT, CYC LOW/HIGH or Error mode) Set seconds (up to 9999.9) to wait before activating relay once the relay condition is true.
<b>R1 PULSE MIN</b> 0.00 UNITS	(ALL except PRESSURE) (Shown only if PROP PLS mode) Set minimum setpoint value for proportional pulsing.
<b>R1 PULSE MAX</b> 100.00 UNITS	(ALL except PRESSURE) (Shown only if PROP PLS mode) Set maximum setpoint value for proportional pulsing.
<b>R1 MAX RATE</b> 120.00 PULSES/MIN	(ALL except PRESSURE) (Shown only if PROP PLS mode) Set desired maximum pulse rate (300 max) <b>NOTE:</b> Pulse width fixed at 100 ms.
<b>R1 PWM MIN</b> 00.0 UNITS	(ALL except PRESSURE and FLOW) (Shown only if PWM mode) Set minimum value for pulse width modulation.
<b>R1 PWM MAX</b> 10.00 UNITS	(ALL except PRESSURE and FLOW) (Shown only if PWM mode) Set maximum value for pulse width modulation.
<b>R1 PWM PERIOD</b> 1.00 SEC	(ALL except PRESSURE and FLOW) (Shown only if PWM mode) Set time value for one complete pulse cycle. (relay ON time + relay OFF time).
<b>R1 CYCLE TIME</b> 0.00 SEC	(ALL) (Shown only if CYC LOW/HIGH mode) Set time in seconds (up to 99999) for relay to remain on. (See discussion on page 15).

## Common Menus

### RELAY Menu

R1 PULSE WIDTH  
1.00  
SEC

(FLOW only) (Shown only if VOL PULS mode) Set time value for one pulse width.

R1 SET TOTAL  
100.00  
UNITS

(FLOW only) (Shown only if TOTAL) Resettable value that, when exceeded, turns relay on. Must reset Totalizer (in VIEW Mode) to clear relay. Set maximum value.

RELAY 1 ACTIVATE  
RED BACKLIGHT  
NO

Select Yes to have the Red Backlight illuminate during relay activation, No to not have the Red Backlight activated by the relay activation

RELAY 1  
TEST RELAY

(ALL) Press ▲ or ▼ to turn relay on or off for testing purposes. Can also be used to reset or latch/unlatch the relay. Does NOT reset the Totalizer.

### OPTION Menu

ENGLISH  
FRANÇ  
DEUTCH  
ESPAÑOL  
中文

Choose desired the language for the 9950. Default English

TIME FORMAT  
24 HR

Choose a time format between a 24 Hour or an AM/PM clock. Default 24 HR

SET TIME  
08:56

Set the time according to the format chosen 00:00

DATE FORMAT  
MM/DD/YYYY

Date Format; MM/DD/YYYY, DD/MM/YYYY, YYYY/MM/DD

SET DATE  
02/25/2016

Set the date according to the format chosen 00/00/0000

SET DECIMAL MARK  
999.99

Choose either comma or point according to local practices. Default 999.99 (point).

SELECT UNITS  
METRIC

Choose METRIC or US CUSTOMARY

**NOTE:** Defaults for most relay functions are dependent upon sensor type and are not listed here.



## Common Menus

### OPTION Menu

<p>WHITE BACKLIGHT</p> <p>AUTO LOW</p>	White Backlight; Off, Low, High, Auto Low, Auto High
<p>RED BACKLIGHT</p> <p>ON</p>	The Red Backlight illuminates when an error condition is detected; Default is ON
<p>DISPLAY</p> <p>BAR GRAPH</p> <p>ON</p>	Display Bar Graph; On, Off
<p>CH2 BAR GRAPH MIN</p> <p>0.00</p> <p>GPM</p>	Enter a value to represent bar at minimum. Default = 0 (ORP = -999).
<p>CH2 BAR GRAPH MAX</p> <p>100.00</p> <p>GPM</p>	Enter a value to represent bar at maximum. Defaults = 100 (Flow, Cond/Res, Temp), 14 (pH), 1000 (ORP), 10 (Lvl/Prs), 5 (4 to 20 mA), 80 (Sal), 20 (DO)
<p>FUNCTION 1</p> <p>NONE</p>	Function 1 - 4, Configure the derived function, up to four functions available. (Refer to page 19 for further detail).
<p>CH1</p> <p>-----</p> <p>GPM DECIMAL</p>	(ALL) Set the decimal to the best resolution for your application for both CH1 and or CH2. The display will automatically scale up to this resolution for each channel. Select 0, 1, 2, 3, or 4 decimal places, (varies by parameter). Default = 1 Decimal Place.
<p>CH1</p> <p>-----</p> <p>°F DECIMAL</p>	(pH, COND/RES, TEMP, SAL, DO only) Set the Temperature decimal to the best resolution for your application for both CH1 and or CH 2. The display will automatically scale up to this resolution. Select 0, 1, or 2. Default = 1 Decimal Place.
<p>CH1</p> <p>-----</p> <p>TOTAL DECIMAL</p>	(FLOW only) Set the decimal to the best resolution for the Permanent and Resettable 2 Totalizer display. The display will automatically scale up to this resolution. Select 0, 1, 2, 3, or 4 decimal places. Default = 1 Decimal Place
<p>CH1</p> <p>TOTAL LOCK</p> <p>OFF</p>	(FLOW only) requires password to reset the resettable totalizer. Select OFF, ON (Does not affect Permanent Totalizer). Default = OFF.
<p>COND/RES</p> <p>AUTORANGE</p> <p>OFF</p>	(CONDUCTIVITY/RESISTIVITY only) Set ON to automatically scale the conductivity/resistivity within range to be displayed. Default = OFF
<p>PASSWORD TYPE</p> <p>STD</p>	(ALL) Select STD, CODE. Default = STD (Refer to page 20 for further detail).
<p>PASSWORD TYPE</p> <p>CODE</p>	(CODE) If code is selected Default Code = 0000 (Refer to page 20 for further detail).

## Common Menus

### OPTION Menu

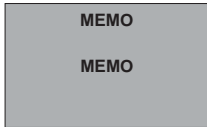

(ALL) Enter 17-character string, if desired.  
Default = MEMO

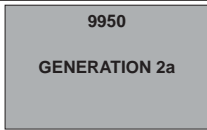

Displays Transmitter Generation Version.



QR code for user manual.

### VIEW Mode

Measurement View Mode Screens are depicted in the Sensor Specific Menus. Below are the screens that all parameters share in common.

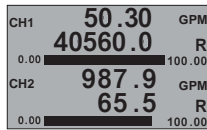

View Measurement 1 displays the primary value with the secondary value below. This is the normal display and does not time out.

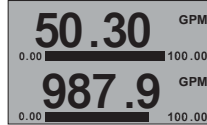

View Measurement 2 displays the primary value in large type. This screen does not time out.

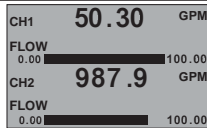

View Measurement 3 displays the primary value and the channel name. This screen does not time out.

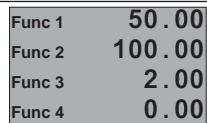

Function values are stated to the right of the function number. Select a derived measurement function, up to four functions available. (SUM, DIFFERENCE, RATIO, %PASSAGE, % REJECT, % RECOVERY A, % RECOVERY B, % RECOVERY C.) See pg 19 for further details.

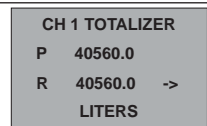

Parameter specific screen.  
Flow totalizer, pH raw mV, ORP, pH Impedance, pH/ORP Sensor Data, raw mV, 4 - 20 mA input, conductivity, DO cap expiration date.

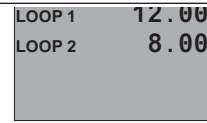

Displays the 4 to 20 mA LOOP output for each channels assigned primary and secondary sources. (3.6, 22.00 are error output values).

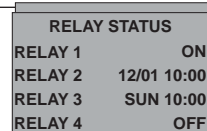

Relay status is stated to the right of the relay number as (OFF, ON, DATE/DAY and TIME) for each relay. If Relay is using Timer Source, time and date of next activation will be displayed. The relay(s) will remain ON while counting down. **NOTE:** (Reset the Timer) In the RELAY menu, select TEST RELAY function. The timer will restart if the condition still exists.

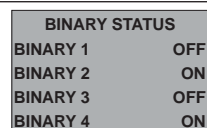

Binary status is stated to the right of the binary channel number as (OFF, ON) for each of the four binary inputs.

## Common Menus

### VIEW Mode

```
SYS CONFIG
CH1          FLOW
CH2          FLOW
RELAY
```

SYS CONFIG shows channel and parameter and relay module part number.

```
GENERATION I
SW VER      00-20 DBG
9950 S/N    0123456789
```

Generation Screen shows version of software and serial number of unit.  
Note: Top shows the Generation of 9950

```
MENU ->
```

MENU-> will allow access to top level menu by pressing the ► key.

```
DATE
```

```
09/01/2016
```

```
09:06
```

DATE and TIME display show the current system date and time

```
EASYCAL
```

```
CH1 pH ->
```

```
CH2 ORP ->
```

pH EASYCAL looks for buffers of 4, 7, or 10 pH buffers. (See page 55).  
ORP EASYCAL looks for buffer of 87, 264, or 476 mV. Press the ► to begin EASYCAL (See page 57).

## Sensor-Specific Menus

### Flow

The following pages list the sensor-specific settings for each sensor type. The user can configure the unit to run each channel on different parameters if needed.

#### VIEW Mode Menu

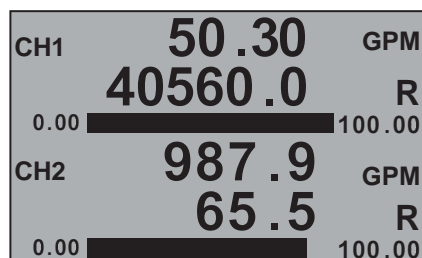

Displays the flow rate and the resettable or permanent totalizer below. This is the normal display and does not time out.

#### FLOW Setup Checklist

1. Make sure FLOW sensor type is selected (see System Setup Menu, page 8).
2. Set the Units of Measurement.
3. Set Sensor Type (Freq or S<sup>3</sup>L) and if 515 or 525 select Yes.
4. If LOOP is used, set the minimum and maximum 4 to 20 mA setpoints.
5. Set K-Factor (pulses per Unit Volume) from Flow Sensor manual.
6. Set Totalizer factor.
7. Set Last Cal Date and initials.
8. If applicable, set up relay functions for your application.

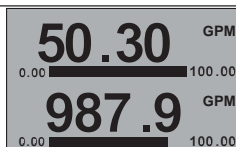

View Measurement 2 displays primary value in large type. This screen does not time out.

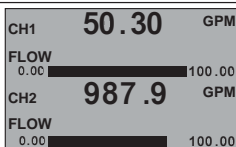

View Measurement 3 displays the primary value and the channel name. This screen does not time out.

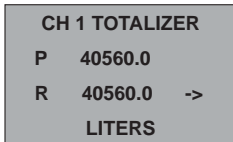

Displays the Permanent Totalizer and Resettable Totalizer for each FLOW channel (note the "P" indicating Permanent and "R" for resettable) Pressing ► will prompt you to reset. Pressing ► again will verify YES or NO. Pressing ENTER will reset the totalizer.

#### CAL Menu

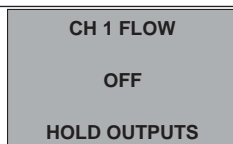

ON prevents relays from activating while making adjustments and relays in PULSE mode will suspend pulsing. Output is held until the user exits the CAL menu or turns it off. Select ON/OFF. Default = OFF.

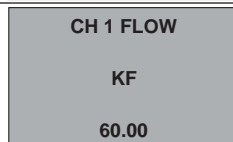

Set K-Factor (pulses per unit volume) from Flow Sensor manual. Min: 0.0001, max. 9999999. Cannot be zero. Default = 60.0000.

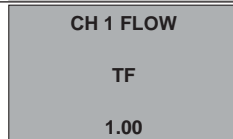

Sets the volume of each count of the Totalizer as a multiple of the volume unit of the K-Factor. Min: 0.0001, max. 9999999. Cannot be zero. Default = 1.0000.

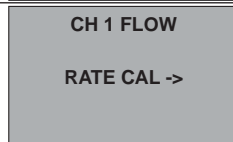

Select to calibrate using rate method (see Appendix, page 60).

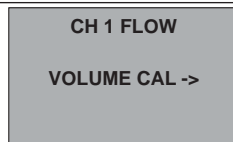

Select to calibrate using Volume method (see Appendix, page 60).

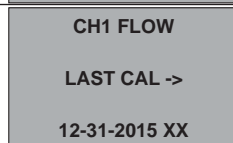

Enter date of calibration (MM-DD-YYYY) and initials of calibrator (XX).

INPUT Menu

<p>CHANNEL 1 NAME FLOW</p>	<p>If desired, a custom name can be entered. Enter 17-character string. Default = FLOW</p>
<p>CH 1 FLOW SENSOR FREQ</p>	<p>If your flow sensor is configured for frequency output, select FREQ. If configured for Digital (S<sup>3</sup>L) output (recommended), select S<sup>3</sup>L. Default = FREQ.</p>
<p>CH 1 FLOW 515/2536 YES</p>	<p>If your flow sensor is self powered such as a 515/525 select YES If your flow sensor is not self powered such as a 2536 select NO Default = YES</p>
<p>CH 1 FLOW GPM FLOW UNITS</p>	<p>Select the unit of measure from the pull down menu. Custom units can be created and used. The last character sets the timebase: S (seconds) M (minutes) H (hours) D (days). Default = GPM.</p>
<p>CH 1 FLOW CUST/S CUSTOM UNITS</p>	<p>Set UNITS to CUST/S, CUST/M, CUST/H, CUST/D allows user to set custom units for primary measurement. CUST/S, M, H, D label can be adjusted to reflect to user's custom units.</p>
<p>TOTALIZER TOTAL UNITS GALLONS</p>	<p>Identifies the Totalizer units. It has no effect on any calculation. Default = GALLONS.</p>
<p>CH1 FLOW DISPLAY R TOTALIZER</p>	<p>Set the Totalizer displayed in view mode. Select R TOTALIZER for resettable or select PERM TOTALIZER for permanent. Default = R TOTALIZER.</p>
<p>CH1 FLOW 100.0 SENSITIVITY</p>	<p>The Sensitivity setting determines how the 9950 responds to sudden changes in the flow rate for a frequency sensor. The value is expressed in units of measurement. If the setting is exceeded, it "overrides" the Averaging function briefly to allow for the actual change in flow rate to be displayed. Averaging resumes shortly after. The result is a smooth flow display and a quick response to large shifts in the flow rate.</p>
<p>CH1 FLOW AVERAGE OFF</p>	<p>Dampens display, output and relay response rates. Select Low, Med, High, OFF. (See discussion in Appendix, page 50). Default = OFF.</p>
<p>CH 1 FLOW TYPE FLOW</p>	<p>Current channel type is listed. Manually change channel type to match sensor type if sensor is not found by S<sup>3</sup>L search. Default = FACTORY, S<sup>3</sup>L sensors will automatically be found by transmitter. All other sensors must be manually set.</p>

**VIEW Mode Menu**



Displays the pH value and the temperature below. This is the normal display and does not time out.

**pH Setup Checklist**

1. Make sure pH sensor type is selected (see System Setup Menu, page 8).
2. Set the Temperature Units (°C or °F).
3. If LOOP is used, set the minimum and maximum 4 to 20 mA setpoints.
4. Perform calibration (EasyCal, Standard or Standard and Slope).
5. Set Last Cal Date and initials.
6. Select source for Relay output (pH or Temp).
7. If applicable, set up relay functions for your application.



View Measurement 2 displays primary value in large type. This screen does not time out.



View Measurement 3 displays the primary value and the channel name. This screen does not time out.

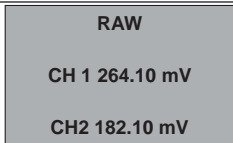

Displays the RAW millivolt input from the electrode. Use this display to determine the relative condition of your electrode during periodic calibration.

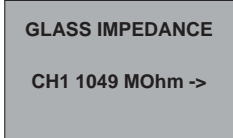

[Glass Impedance] 2751 only, pH only, last measured glass Impedance, press [RIGHT] key to manually update reading

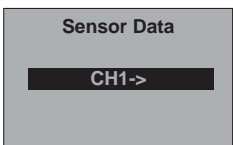

2571 only. Using the right arrow key, you will see the following screens: [Serial Number] Electrode Serial Number, [Model Number] Electrode Model Number, [pH Calibration Slope] Calibration Slope Value, [pH Offset] Calibration Offset, [Temperature Offset] pH only, Temperature Offset Value, [Factory Impedance] pH only, Factory pH glass Impedance, [Usage Time] Electrode Runtime in Hours, [Minimum pH] Minimum measured value, [Maximum pH] Maximum measured Value, [Minimum Temperature] pH only, minimum measured temperature, [Maximum Temperature] pH only, maximum measured temperature

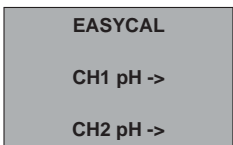

pH EASYCAL looks for buffers of 4, 7, or 10 pH buffers. (Refer to page 55).

## CAL Menu

CH 2 pH OFF HOLD OUTPUTS	ON prevents relays from activating while making adjustments and relays in PULSE mode will suspend pulsing. 4 to 20 mA output is held until the user exits the CAL menu or turns it OFF. Select ON/OFF. Default = OFF.
CH 2 pH CAL AT INSTRUMENT	Select AT SENSOR to perform calibration using the Signet 2750 sensor electronics. Select AT INSTRUMENT to perform calibration at the 9950 via EasyCal or manual calibration. (See pH Calibration procedures in the Appendix, page 56). Default = AT INSTRUMENT
CH 2 pH EASYCAL ->	(CAL AT INSTRUMENT only) Press ► to start the EasyCal process. The password prompt is the same as the other parameters. (See pH EasyCal procedure in the Appendix, page 55).
CH 2 pH SET TEMPERATURE ->	(CAL AT INSTRUMENT only) Applies a linear offset to the temperature measurement. "SAVING" will appear if offset is acceptable, "ERR TOO LARGE TO CALIBRATE" if offset is outside of range.
CH 2 pH SET pH STANDARD ->	(CAL AT INSTRUMENT only) Applies an offset to the pH measurement. The slope value and the standard value must be at least 2 pH units apart. The ideal values are the minimum and maximum values of your process. (See pH Calibration procedures in the Appendix, page 55). Shows error message if offset is too high.
CH2 pH SET pH SLOPE	(CAL AT INSTRUMENT only) Applies a slope to the pH measurement. The slope value and the standard value must be at least 2 pH units apart. The ideal values are the minimum and maximum values of your process. (See pH Calibration procedures in the Appendix, page 55.) Shows error message if slope is too low or high
CH2 pH SET RESET pH CAL ->	(CAL AT INSTRUMENT only) Press ► to reset pH Calibration to factory default.
CH2 pH RESET TEMPCAL ->	(CAL AT INSTRUMENT only) Press ► to reset temperature calibration to factory default.
CH 2 pH LAST CAL 12 - 31 - 2015 XX	Enter date of calibration (MM-DD-YYYY) and initials of calibrator (XX).

## INPUT Menu

<p>CHANNEL 2</p> <p>NAME</p> <p>pH</p>	<p>If desired, a custom name can be entered. Enter 17-character string. Default = pH</p>
<p>CH 2 pH</p> <p>°F</p> <p>AT INSTRUMENT</p>	<p>Select °F or °C. Default = Determined by the SELECT UNITS screen menu. Metric = °C, U.S. Customary = °F.</p>
<p>CH 2 pH</p> <p>AVERAGE</p> <p>OFF</p>	<p>Dampens display, output and relay response rates. Select Low, Med, High, OFF. Default = OFF. (See discussion in Appendix, page 50). <b>NOTE:</b> Signet strongly recommends leaving averaging OFF for pH and Pressure measurements</p>
<p>CH 1 pH</p> <p>60</p> <p>IMP UPDATE TIME</p>	<p>2751, pH Only. Enter the time between automatic impedance measurement updates in 15 minute increments, 0 = Off - manual updates only</p>
<p>CH 1 pH</p> <p>3X</p> <p>HI IMP WARN</p>	<p>2751, pH only. Enter the high Impedance warning set point as off, or 3, 4, or 5 times the factory Impedance of the electrode.</p>
<p>CH 2 pH</p> <p>TYPE</p> <p>pH</p>	<p>Current channel type is listed. Manually change channel type to match sensor type if sensor is not found by S<sup>3</sup>L search. Default = FACTORY, S<sup>3</sup>L sensors will automatically be found by transmitter. All other sensors must be manually set.</p>



VIEW Mode Menu

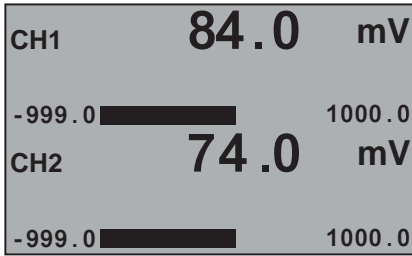

Displays the ORP millivolt value. This is the normal display and does not time out.

ORP Setup Checklist

1. Make sure ORP sensor type is selected (see System Setup Menu, page 8).
2. If LOOP is used, set the minimum and maximum 4 to 20 mA setpoints.
3. Set Averaging.
4. Perform calibration or set Standard (and Slope if desired).
5. Set Last Cal Date and initials.
6. If applicable, set up relay functions for your application.

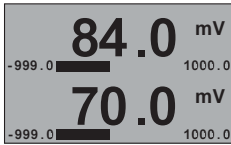

View Measurement 2 displays primary value in large type. The screen does not time out.



View Measurement 3 Displays the primary value along with the channel name. The screen does not time out.

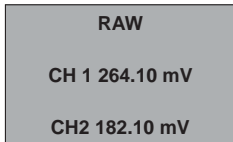

Displays the RAW millivolt input from the electrode. Use this display to determine the relative condition of your electrode during periodic calibration.

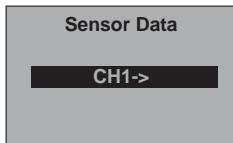

2571 only. Using the right arrow key, you will see the following screens: [Serial Number] Electrode Serial Number, [Model Number] Electrode Model Number, [ORP Calibration Slope] Calibration Slope Value, [ORP Calibration Offset] Calibration Offset, [Usage Time] Electrode Runtime in Hours, [Minimum ORP] Minimum measured value, [Maximum ORP] Maximum measured Value.

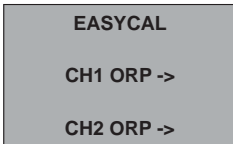

ORP EASYCAL looks for buffer of 87, 264, or 476 mV. Press the ► to begin EASYCAL (See page 57)

**CAL Menu**

<p>CH 2 ORP OFF HOLD OUTPUTS</p>	<p>ON prevents relays from activating while making adjustments and relays in PULSE mode will suspend pulsing. Output is held until the user exits the CAL menu or turns it OFF. Select ON/OFF. Default = OFF</p>
<p>CH 2 ORP CAL AT INSTRUMENT</p>	<p>Select AT SENSOR to perform calibration using the Signet 2750 sensor electronics. Select AT INSTRUMENT to perform calibration at the 9950 via EasyCal or manual calibration. (See ORP Calibration procedures in the Appendix, page 58). Default = AT INSTRUMENT.</p>
<p>CH 2 ORP EASYCAL -&gt;</p>	<p>(CAL AT INSTRUMENT only) Press ► to start the EasyCal process. You will be prompted to enter your password. (See ORP EasyCal procedure in the Appendix, page 57).</p>
<p>CH 2 ORP SET ORP STANDARD -&gt;</p>	<p>(CAL AT INSTRUMENT only) Applies a linear offset to the ORP measurement. For two-point calibrations, assign the min or max value of your process to ORP STANDARD. (See ORP Calibration procedures in the Appendix, page 58).</p>
<p>CH 2 ORP SET ORP SLOPE -&gt;</p>	<p>(CAL AT INSTRUMENT only) Applies a slope to the ORP measurement. The ORP SLOPE is used for two-point calibration along with the ORP STANDARD. If you applied the min value of your process to the ORP STANDARD, then apply the max value to the ORP SLOPE. Else, apply the min value to the ORP SLOPE. The slope value and the standard value must be at least 80 mV apart. (See ORP Calibration procedures in the Appendix, page 58).</p>
<p>CH2 ORP RESET ORP CAL -&gt;</p>	<p>(CAL AT INSTRUMENT only) Resets calibration to factory settings. After pressing ►, select YES/NO.</p>
<p>CH2 ORP LAST CAL 12-31-2015 XX</p>	<p>Enter date of calibration (MM-DD-YYYY) and initials of calibrator (XX)</p>

**INPUT Menu**

<p>CHANNEL 2 NAME ORP</p>	<p>If desired, a custom name can be entered. Enter 17-character string. Default = ORP</p>
<p>CH 2 ORP AVERAGE OFF</p>	<p>Dampens display, output and relay response rates. Select Low, Med, High, OFF. (See discussion in Appendix, page 50). Default = OFF.</p>
<p>CH 2 ORP TYPE ORP</p>	<p>Current channel type is listed. Manually change channel type to match sensor type if sensor is not found by S<sup>3</sup>L search. Default = FACTORY, S<sup>3</sup>L sensors will automatically be found by transmitter. All other sensors must be manually set.</p>

## Conductivity / Resistivity

### VIEW Mode Menu

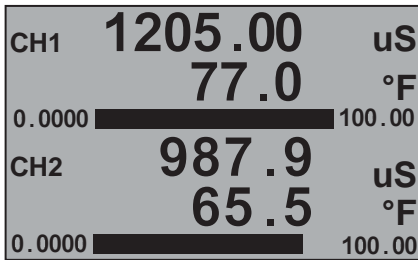

Displays the conductivity value and the temperature below. This is the normal display and does not time out.

### Cond/Res Setup Checklist

1. Make sure COND/RES sensor type is selected (see System Setup Menu, page 8).
2. Set Cell Constant.
3. Set the Temperature Units (°C or °F).
4. Set Conductivity units.
5. If LOOP is used, set the minimum and maximum 4 to 20 mA setpoints.
6. Set Temperature Compensation.
7. Set Last Cal Date and initials.
8. Select source for Relay output (COND or TEMP).
9. If applicable, setup relay functions for your application.

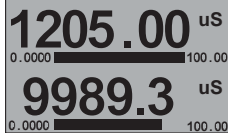

View Measurement 2 displays the conductivity in large type and the bar graph below. The screen does not time out.

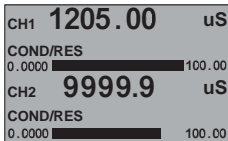

View Measurement 3 displays the primary value and the channel name. The screen does not time out.

### CAL Menu

CH 2 COND/RES

OFF

HOLD OUTPUTS

ON prevents relays from activating while making adjustments, and relays in PULSE mode will suspend pulsing. Output is held until the user exits the CAL menu or turns it OFF. Select OFF/ON. Default = OFF.

CH 2 COND/RES

AUTO CAL ->

Shows real-time value and automatically selects closest standard. "PLACE SENSOR IN STANDARD". Unit waits until reading is stable; if bad calibration, returns "ERROR, CANNOT DETERMINE STANDARD". Refer to buffer values and AUTO CAL Procedure in the Appendix, page 59.

CH 2 COND/RES

MANUAL CAL ->

Shows "CONDUCTIVITY" on bottom line; when user presses any button the live value is frozen and the user edits that value. If bad calibration, returns "ERR TOO LARGE TO CALIBRATE". See Manual Cal procedure in Appendix, page 59.

CH 2 COND/RES

SET

TEMPERATURE

Shows "TEMPERATURE" on bottom line; when user presses any button the live value is frozen and the user edits that value. If bad calibration, returns "ERR TOO LARGE TO CALIBRATE".

CH 2 COND/RES

RESET CONDCAL ->

Resets Conductivity calibration. After pressing ►, select YES/NO.

CH2 COND/RES

RESET TEMPCAL ->

Resets Temperature calibration. After pressing ►, select YES/NO.

CH2 COND/RES

LAST CAL

12-31-2015 XX

Enter date of calibration (MM-DD-YYYY) and initials of calibrator (XX)

## Conductivity / Resistivity

### INPUT Menu

<p>CHANNEL 2</p> <p>NAME</p> <p>COND/RES</p>	<p>If desired, a custom name can be entered. Enter 17-character string. Default = COND/RES</p>
<p>CH 2 COND/RES</p> <p>SENSOR 1.0</p> <p>CELL CONSTANT</p>	<p>Enter cell constant of sensor. Select 20.0, 10.0, 1.0, 0.1, 0.01, or CUSTOM. Default = 1.0 (See NOTE below)</p>
<p>CH 2 COND/RES</p> <p>SENSOR 1.00000</p> <p>CUST CELL CONST</p>	<p>Enter the precise cell constant from the certificate provided with your sensor or from the information label on the sensor if CUST (custom) cell constant is selected.</p>
<p>CH 2 COND/RES</p> <p>µS</p> <p>COND UNITS</p>	<p>Select µS, mS, PPM, PPB, KOhm, or MOhm. Default = µS. NOTE: In USP Relay Mode, TEMP COMP must be set to NONE and Unit Of Measure must be set to µS.</p>
<p>CH 2 COND/RES</p> <p>0.50</p> <p>TDS FACTOR</p>	<p>If PPM or PPB units are selected, a TDS factor for converting total dissolved solids is required. Default = 0.50</p>
<p>CH2 COND/RES</p> <p>°F</p> <p>TEMP UNITS</p>	<p>Select °F or °C. Default = Determined by the SELECT UNITS screen menu. Metric = °C, U.S. Customary = °F.</p>
<p>CH2 COND/RES</p> <p>AVERAGE</p> <p>OFF</p>	<p>Dampens display, output and relay response rates. Select Low, Med, High, OFF. (See discussion in Appendix, page 50). Default = OFF.</p>
<p>CH2 COND/RES</p> <p>TEMP COMP</p> <p>LINEAR</p>	<p>Select temperature compensation (NONE, LINEAR, PURE H2O). Default = LINEAR. NOTE: In USP Relay Mode in Conductivity, Relay Source must be set to COND, TEMP COMP must be set to NONE and Unit Of Measure must be set to µS.</p>
<p>CH 2 COND/RES</p> <p>2.0</p> <p>ADJ TEMP COMP</p>	<p>Adjusted the % of temperature compensation. Maximum slope setting is 9.99 % per °C. Default = 2.0 (If Temperature Compensation setting is NONE, this item will not be displayed)</p>
<p>CH2 COND/RES</p> <p>TYPE</p> <p>COND/RES</p>	<p>Current channel type is listed. Manually change channel type to match sensor type if sensor is not found by S<sup>3</sup>L search. Default = FACTORY, S<sup>3</sup>L sensors will automatically be found by transmitter. All other sensors must be manually set.</p>

### Factory-Set Span:

0.01 cell (2819, 2839) ..... 0 to 100 µS  
 0.10 cell (2820, 2840) ..... 0 to 1000 µS  
 1.0 cell (2821, 2841) ..... 0 to 10,000 µS  
 10.0 cell (2822, 2842) ..... 0 to 200,000 µS  
 20.0 cell (2823) ..... 0 to 400,000 µS



**NOTE:** Relay will activate if USP limit is exceeded, Temperature Comp is set to Linear or Pure Water, Conductivity Measurement is NOT in uS, or if the Conductivity is reporting a measurement error.

**NOTE:** If using a 2850 Conductivity/Resistivity Sensor Electronics in conjunction with your 9950, the 2850 must be set for either the custom cell constant or the actual probe cell constant and the 9950 set for a 1.0 cell constant.

## Pressure

### VIEW Mode Menu



Displays the pressure reading. This is the normal display and does not time out.

### PRESSURE Setup Checklist

1. Make sure PRESSURE sensor type is selected (see System Setup Menu, page 8).
2. If LOOP is used, set the minimum and maximum 4 to 20 mA setpoints.
3. Set Units of Measurement (PSI, BAR, KPa).
4. Set Last Cal Date and initials.
5. If applicable, set up relay functions for your application.

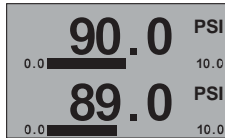

View Measurement 2 displays primary value in large type. This screen does not time out.

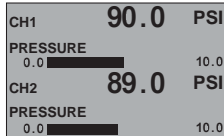

View Measurement 3 displays the primary value and the channel name. This screen does not time out.

### CAL Menu

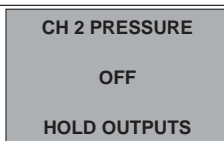

ON prevents relays from activating while making adjustments, and relays in PULSE mode will suspend pulsing. Output is held until the user exits the CAL menu or turns it OFF. Select OFF/ON. Default = OFF.

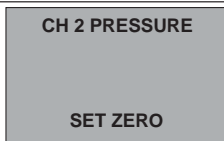

With process pressure at zero, set zero point for measurement.

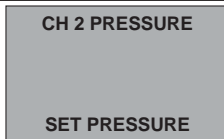

Calibrate pressure reading to external reference. Provides a maximum 5 psi offset.

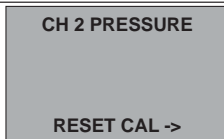

Resets calibration to factory default. After pressing ►, select YES/NO.

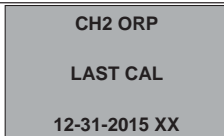

Enter date of calibration (MM-DD-YYYY) and initials of calibrator (XX)

## Pressure

### INPUT Menu

<p>CHANNEL 2 NAME PRESSURE</p>	<p>If desired, a custom name can be entered. Enter 17-character string. Default = PRESSURE</p>
<p>CH 2 PRESSURE PSI PRESS UNITS</p>	<p>Enter units of pressure measurement. Select PSI, BAR, or KPa. Default = Determined by the SELECT UNITS screen menu. Metric = Bar, U.S. Customary = PSI.</p>
<p>CH 2 PRESSURE AVERAGE OFF</p>	<p>Dampens display, output and relay response rates. Select: Low, Med, High, OFF (see discussion in Appendix, page 50). Default = OFF. Signet strongly recommends leaving averaging OFF for pH and pressure measurements</p>
<p>CH 2 PRESSURE TYPE PRESSURE</p>	<p>Current channel type is listed. Manually change channel type to match sensor type if sensor is not found by S<sup>3</sup>L search. Default = FACTORY, S<sup>3</sup>L sensors will automatically be found by transmitter. All other sensors must be manually set.</p>

## Level / Volume

### VIEW Mode Menu

CH1	25.0	FT
	78.5	GAL
0.0000		10.000
CH2	20.0	FT
	99.0	GAL
0.0000		10.000

Displays the level value and the volume below. This is the normal display and does not time out.

### LEVEL/VOLUME Setup Checklist

1. Make sure LEVEL/VOLUME sensor type is selected (see System Setup Menu, page 8).
2. Select Main Measurement (Level or Volume).
3. Set Units of Measurement for LEVEL display (FT, IN, M, CM).
4. If desired, set Units of Measurement for VOLUME display.
5. Set the minimum and maximum 4 to 20 mA setpoints.
6. Set Specific Gravity.
7. Set Sensor Offset.
8. If VOLUME is used, set Shape.
9. Set Last Cal Date and initials.
10. If applicable, set up relay functions for your application.

	25.0	FT
0.0000		10.000
	20.0	FT
0.0000		10.000

View Measurement 2 displays primary value in large type. This screen does not time out.

CH1	25.0	FT
LEVEL		10.000
CH2	42.0	FT
LEVEL		10.000

View Measurement 3 displays the primary value and the channel name. This screen does not time out.

### CAL Menu

CH 2 LEVEL
OFF
HOLD OUTPUTS

ON prevents relays from activating while making adjustments, and relays in PULSE mode will suspend pulsing. Output is held until the user exits the CAL menu or turns it OFF. Select OFF/ON. Default = OFF.

CH 2 LEVEL
LEVEL CAL

Shows SET LEVEL on bottom line. When user presses any key, the live value is frozen and the user edits that value. Returns either GOOD CAL or LEVEL OFFSET TOO LARGE.

CH 2 LEVEL
RESET CAL

Resets calibration to factory default. After pressing ►, select YES/NO.

CH2 LEVEL
LAST CAL
12-31-2015 XX

Enter date of calibration (MM-DD-YYYY) and initials of calibrator (XX)

### INPUT Menu

CHANNEL 2
NAME
LEVEL

If desired, a custom name can be entered. Enter 17-character string. Default = LEVEL

CH 2 LEVEL
MAIN MEAS
LEVEL

Select between Level or Volume. Default = LEVEL.

## Level / Volume

### INPUT Menu

<p>CH 2 LEVEL</p> <p>M</p> <p>LEVEL UNITS</p>	<p>Select unit of measure for LEVEL display (FT, IN, M, CM). Default = Determined by the SELECT UNITS screen menu. Metric = M, U.S. Customary = FT.</p>
<p>CH 2 LEVEL</p> <p>DISP LEVEL AS %</p> <p>OFF</p>	<p>ON = Measurement will be displayed as a percentage of full scale. OFF = Measurement will be displayed in unit of measure selected in previous setting. Default = OFF.</p>
<p>CH2 LEVEL</p> <p>L</p> <p>VOLUME UNITS</p>	<p>Select unit of measure for VOLUME display (GAL, L, Lb, KG, FT<sup>3</sup>, in<sup>3</sup>, M<sup>3</sup>, cm<sup>3</sup>). Default = Determined by the SELECT UNITS screen menu. Metric = L, U.S. Customary = GAL.</p>
<p>CH 2 LEVEL</p> <p>DISP VOL AS %</p> <p>OFF</p>	<p>ON = Measurement will be displayed as a percentage of full scale. OFF = Measurement will be displayed in unit of measure selected in previous setting. Default = OFF.</p>
<p>CH 2 LEVEL</p> <p>1.00</p> <p>SPEC GRAVITY</p>	<p>Enter the specific gravity of the fluid at normal operating temperature. Default = 1.0000 (water).</p>
<p>CH 2 LEVEL</p> <p>0.00</p> <p>SENSOR OFFSET</p>	<p>Enter the distance from sensor location to the Zero reference point in the vessel (see discussion in Appendix). Displayed in units of measure chosen in LEVEL UNITS. Default = 0.00.</p>
<p>CH2 LEVEL</p> <p>AVERAGE</p> <p>OFF</p>	<p>Dampens display, output and relay response rates. Select Low, Med, High, OFF (See discussion in Appendix, page 50). Default = OFF</p>
<p>CH 2 LEVEL</p> <p>VERT CYLINDER</p> <p>SHAPE</p>	<p>Select the shape of the vessel where the level sensor is located. VERT CYLINDER, HORIZ CYLINDER, RECTANGLE, or CUSTOM. (To define a custom tank shape, see Appendix page 51, Defining a Custom Tank.) Default = VERT CYLINDER</p>
<p>M</p> <p>2.00</p> <p>TANK DIAMETER</p>	<p>If VERT CYLINDER or HORIZ CYLINDER is selected, enter the diameter of the cylinder. Displayed in units of measure chosen in LEVEL UNITS. Default = 2.0000</p>



## Level / Volume

### INPUT Menu

<p>FT</p> <p>10.00</p> <p>TANK LENGTH</p>	<p>Set length of tank. Default = 10.00</p>
<p>FT</p> <p>10.0</p> <p>TANK WIDTH</p>	<p>Set width of tank Default = 10.00</p>
<p>CH 2 LEVEL</p> <p>4</p> <p>NUM CUST POINTS</p>	<p>If Custom shape is selected, enter the number of measurement points to be used to define the vessel shape (see Level and Volume Calculation in Custom Shaped Vessels discussion, page 52). Minimum 4 points, maximum 32 points. A larger number of points improves accuracy.</p>
<p>CH 2 LEVEL</p> <p>MANUAL</p> <p>LEVEL CALC</p>	<p>Select (AUTO, MANUAL). Manual allows you to edit both the Level and the corresponding Volume for your custom tank. Automatic allows you to edit the Volume measurement (while displaying an automatically calculated Level value).</p>
<p>FT</p> <p>0.00</p> <p>POINT X LEVEL</p>	<p>Where (X) is number of custom points used to calculate level.</p>
<p>FT</p> <p>0.00</p> <p>POINT X VOL</p>	<p>Where (X) is number of custom points used to calculate level.</p>
<p>CHANNEL 2</p> <p>TYPE</p> <p>LEVEL</p>	<p>Current channel type is listed. Manually change channel type to match sensor type if sensor is not found by S<sup>3</sup>L search. Default = FACTORY, S<sup>3</sup>L sensors will automatically be found by transmitter. All other sensors must be manually set.</p>

## Temperature

### VIEW Mode Menu

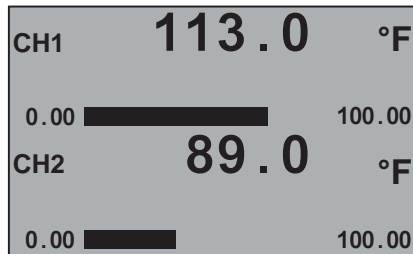

Displays the temperature value.  
This is the normal display and does not time out.

### TEMPERATURE Setup Checklist

1. Make sure TEMPERATURE sensor type is selected (see System Setup Menu, page 8).
2. If LOOP is used, set the minimum and maximum 4 to 20 mA setpoints.
3. Set Units of Measurement (°C or °F).
4. Set Last Cal Date and initials.
5. If applicable, set up relay functions for your application.



View Measurement 2 displays primary value in large type. This screen does not time out.

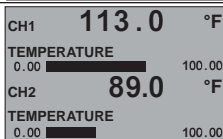

View Measurement 3 displays the primary value and the channel name. This screen does not time out.

### CAL Menu

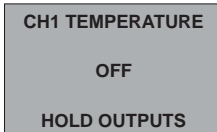

ON prevents relays from activating while making adjustments, and relays in PULSE mode will suspend pulsing. Output is held until the user exits the CAL menu or turns it OFF. Select OFF/ON.  
Default = OFF.

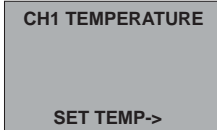

Provides a maximum 20 °C offset to match to a known standard (external reference).

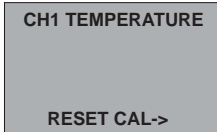

Resets Temperature Calibration to factory settings. After pressing ►, select YES/NO.

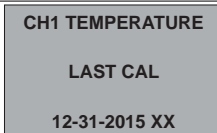

Enter date of calibration (MM-DD-YYYY) and initials of calibrator (XX)

### INPUT Menu

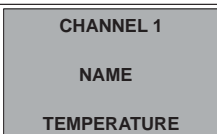

If desired, a custom name can be entered.  
Enter 17-character string.  
Default = TEMPERATURE

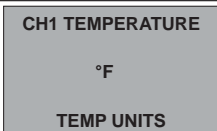

Select °F or °C.  
Default = Determined by the SELECT UNITS screen menu. Metric = °C, U.S. Customary = °F.

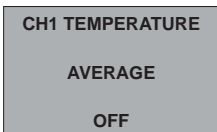

Dampens display, output and relay response rates.  
Select Low, Med, High, OFF. (See discussion in Appendix, page 50).  
Default = OFF.

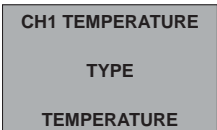

Current channel type is listed. Manually change channel type to match sensor type if sensor is not found by S<sup>3</sup>L search.  
Default = FACTORY, S<sup>3</sup>L sensors will automatically be found by transmitter.  
All other sensors must be manually set.

**VIEW Mode Menu**

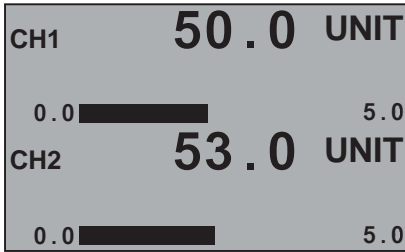

Displays the input value. This is the normal display and does not time out.

**4 to 20 mA Setup Checklist**

1. Make sure 4 to 20 mA INPUT sensor type is selected (see System Setup Menu, page 8).
2. Set 4 mA value (refer to your 3rd-party sensor manual).
3. Set 20 mA value (refer to your 3rd-party sensor manual).
4. If LOOP is used, set the minimum and maximum 4 to 20 mA setpoints.
5. Set Last Cal Date and initials.
6. If applicable, set up relay functions for your application.

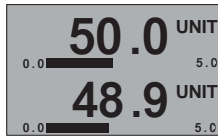

View Measurement 2 displays primary value in large type. This screen does not time out.

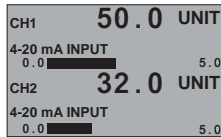

View Measurement 3 displays the primary value and the channel name. This screen does not time out.

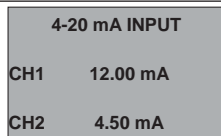

4 to 20 mA input live readout.

**CAL Menu**

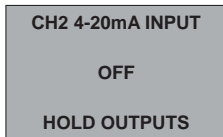

ON prevents relays from activating while making adjustments, and relays in PULSE mode will suspend pulsing. Output is held until the user exits the CAL menu. Select OFF/ON. Default = OFF.



Applies a linear offset to the measurement. For single point calibrations, assign the average value of your process to STANDARD. For two-point calibrations, assign the min or max value of your process to STANDARD.



Applies a slope to the measurement. The SLOPE is used for two-point calibrations along with the STANDARD above. If you assigned the min value of your process to the STANDARD, then assign the max value to the SLOPE. Else, assign the min value to the SLOPE. The slope and standard values must be at least 0.1 units apart.

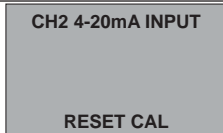

Resets Standard and Slope calibration to factory settings. After pressing ►, select YES/NO.

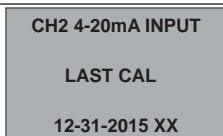

Enter date of calibration (MM-DD-YYYY) and initials of calibrator (XX).

## INPUT Menu

<b>CHANNEL 2</b> <b>NAME</b> 4-20mA INPUT	If desired, a custom name can be entered. Enter 17-character string. Default = 4-20 mA
<b>CH2 4-20mA INPUT</b> <b>UNIT</b> SENSOR UNITS	Enter up to 4 characters describing unit of measure. Default = UNIT.
<b>CH2 4-20 mA INPUT</b> 0.00 4 mA VALUE	Measurement value of your sensor when its output is 4.00 mA.
<b>CH2 4-20mA INPUT</b> 100.00 20 mA VALUE	Measurement value of your sensor when its output is 20.00 mA.
<b>CH2 4-20mA INPUT</b> <b>AVERAGE</b> OFF	Dampens display, output and relay response rates. Select Low, Med, High, OFF. (See discussion in Appendix, page 50). Default = OFF
<b>CH2 4-20mA INPUT</b> <b>TYPE</b> 4-20mA INPUT	Current channel type is listed. Manually change type to match sensor type if sensor is not found by S <sup>3</sup> L search. Default - FACTORY, S <sup>3</sup> L sensors will automatically be found by transmitter. All other sensors must be manually set.

### To program the 9950 for Dissolved Oxygen measurement using the 3-2610-31 sensor and 8058 iGo Signal Converter:

From the 4 to 20 mA View Mode display:

1. Press and hold the ENTER key for 2 seconds.
2. Press the ▼ key to select the INPUT menu.
3. The first item is NAME. Press the ► key to select correct channel (CH1 or CH2), change the displayed name from "4-20 mA"INPUT" to a more descriptive name (e.g., DO) and press ENTER when done.
4. Press ▼ to select SENSOR UNIT menu item.
5. Press ► to change the label from UNIT to MG/L and press ENTER.
6. Press ▼ and ensure the 4 mA VALUE is set to 0.0000.
7. Press ▼ and change the 20 mA VALUE from 5.0000 to 20.000 and press ENTER.
8. Press both ▲ and ▼ simultaneously to return to the Menu.
9. Press ▼ to select the LOOP menu and press ENTER. Set to source Channel x Primary.
10. Set the 4 mA SETPOINT to your desired value. The 2610 is factory set for a 0 to 20 mg/L output. Press ENTER when done.
11. Press the ▼ key to select the 20 mA SETPOINT and set to your desired value. The 2610 is factory set for a 0 to 20 mg/L output. Press ENTER when done.
12. Press both ▲ and ▼ simultaneously to return to the Menu.
13. Press ▼ twice to select the OPTION menu and press ENTER.
14. Press ▼ twice to select correct channel SET BAR MIN. Change this option if desired. The 2610 is factory set for a 0 to 20 mg/L output. Press ENTER on correct channel when done.
15. Press ▼ to select SET BAR MAX. Change this option if desired. The 2610 is factory set for a 0 to 20 mg/L output. Press ENTER when done.
16. Press both ▲ and ▼ simultaneously to return to the Menu.
17. ENTER the other menus and set the unit as desired for your application.
18. Press both ▲ and ▼ simultaneously to return to the View Menu.

# Salinity

## VIEW Mode Menu

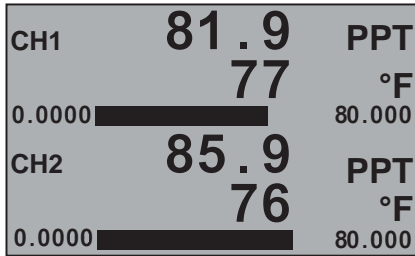

Displays the value and the temperature below. This is the normal display and does not time out.

## Setup Checklist

1. Make sure SALINITY sensor type is selected (see System Setup Menu, page 8).
2. Set Cell Constant.
3. Set the Temperature Units (°C or °F).
4. If LOOP is used, set the minimum and maximum 4 to 20 mA setpoints.
5. Set Last Cal Date and initials.
6. Select source for Relay output (SAL or TEMP).
7. If applicable, set up relay functions for your application.

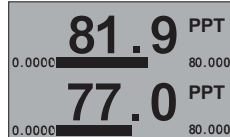

View Measurement 2 displays primary value in large type. This screen does not time out.

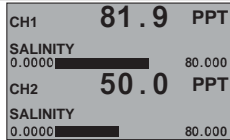

View Measurement 3 displays the primary value and the channel name. This screen does not time out.

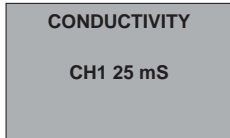

Displays the equivalent conductivity value in millisiemens.

## CAL Menu

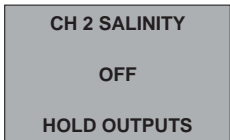

ON prevents relays from activating while making adjustments, and relays in PULSE mode will suspend pulsing. Output is held until the user exits the CAL menu or turns it OFF. Select OFF/ON. Default = OFF.

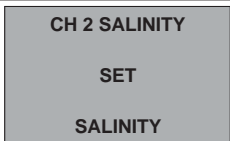

Manually set value to match to a known standard (external reference).

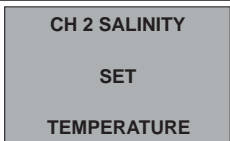

Provides a maximum 20 °C offset to match to a known standard (external reference).

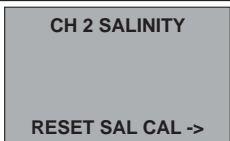

Resets Salinity calibration to factory settings. After pressing ►, select YES/NO.

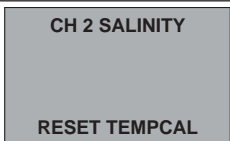

Resets Temperature calibration to factory settings. After pressing ►, select YES/NO.

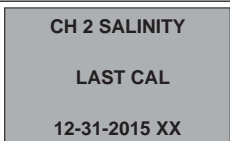

Enter date of calibration (MM-DD-YYYY) and initials of calibrator (XX)

## Salinity

### INPUT Menu

<p>CHANNEL 2</p> <p>NAME</p> <p>SALINITY</p>	<p>If desired, a custom name can be entered. Enter 17-character string. Default = SALINITY</p>
<p>CH 2 SALINITY</p> <p>20.0</p> <p>CELL CONSTANT</p>	<p>Enter cell constant of sensor. Select 20.0, 10.0, 1.0 or CUSTOM. Default = 20.</p>
<p>CH 2 DO</p> <p>50.0000</p> <p>CUST CELL CONST</p>	<p>Enter the precise cell constant from the certificate provided with your sensor or from the information label on the sensor. Shown if CELL CONSTANT = CUSTOM.</p>
<p>CH2 SALINITY</p> <p>°F</p> <p>TEMP UNITS</p>	<p>Select °F or °C. Default = Determined by the SELECT UNITS screen menu. Metric = °C, U.S. Customary = °F.</p>
<p>CH 2 SALINITY</p> <p>AVERAGE</p> <p>OFF</p>	<p>Dampens display, output and relay response rates. Select Low, Med, High, OFF. (See discussion in Appendix, page 50). Default = OFF.</p>
<p>CH 2 SALINITY</p> <p>TEMP COMP</p> <p>LINEAR</p>	<p>Select temperature compensation (NONE, LINEAR). Default = LINEAR.</p>
<p>CH 2 SALINITY</p> <p>2.00</p> <p>ADJ TEMP COMP</p>	<p>For LINEAR temperature compensation, select a % per °C slope. Maximum slope setting is 9.99 % per °C. (If Temperature Compensation setting is NONE, this item will not be displayed.) Default = 2.00</p>
<p>CH 2 SALINITY</p> <p>TYPE</p> <p>SALINITY</p>	<p>Current channel type is listed. Manually change channel type to match sensor type if sensor is not found by S<sup>3</sup>L search. Default = FACTORY, S<sup>3</sup>L sensors will automatically be found by transmitter. All other sensors must be manually set.</p>

## Dissolved Oxygen

### VIEW Mode Menu

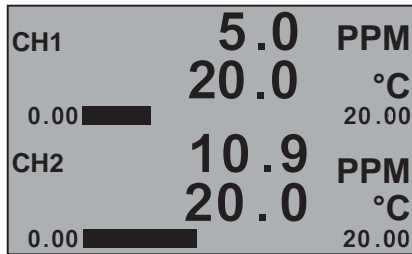

This is the normal display and does not time out.

### DISSOLVED OXYGEN Setup Checklist (3-2610-41)

2610 wiring on page 4.

1. Make sure DISSOLVED OXYGEN sensor type is selected (see System Setup Menu, page 8).
2. Set Units of Measurement (PPM, %SAT, TOR).
3. Set the Temperature Units (°C or °F).
4. Set Salinity reference value.
5. Set Barometric reference value.
6. If LOOP is used, set the minimum and maximum 4 to 20 mA setpoints.
7. Select source for Relay output (PPM or TEMP).
8. If applicable, set up relay functions for your application.

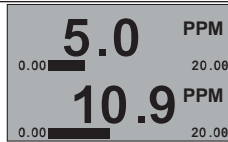

View Measurement 2 displays primary value in large type. This screen does not time out.

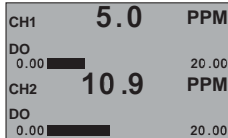

View Measurement 3 displays the primary value and the channel name. This screen does not time out.

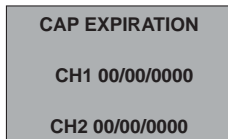

Displays Cap Expiration Date MM-DD-YYYY. If sensor cap is missing, CH# 00/00/0000 will be displayed.

### CAL Menu

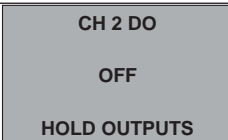

ON prevents relays from activating while making adjustments, and relays in PULSE mode will suspend pulsing. Output is held until the user exits the CAL menu or turns it OFF. Select OFF/ON. Default = OFF.

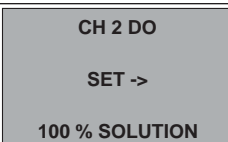

Allows user to initiate the calibration process.  
**NOTE:** Dissolved Oxygen sensors are calibrated at the factory and do not require regular calibration. Press ► to begin the calibration process. User will be prompted to place sensor in 100% Solution standard. Press ENTER to save value and establish a calibration point. If a single point calibration is desired press the UP and DOWN keys to exit.

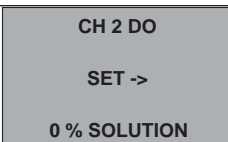

**NOTE:** 100% calibration must be performed first to allow access to the 0% calibration screen. Dissolved Oxygen sensors are calibrated at the factory and do not require regular calibration. Press ► to begin the calibration process. User will be prompted to place sensor in 0% Solution standard. Press ENTER to save value and establish a calibration point.

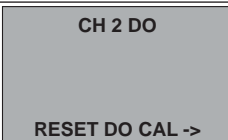

Resets Dissolved Oxygen calibration to factory settings. After pressing ►, select YES/NO.

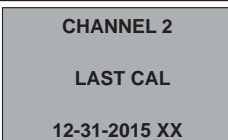

Enter date of calibration (MM-DD-YYYY) and initials of calibrator (XX)

## Dissolved Oxygen

### INPUT Menu

<p>CH2 DO</p> <p>NAME</p> <p>DO</p>	<p>If desired, a custom name can be entered. Enter 17-character string. Default = DO</p>
<p>CH2 DO</p> <p>PPM</p> <p>MEASUREMENT</p>	<p>Set the units of measurement: PPM = DO in mg/L; %SAT = DO % saturation; TOR = Oxygen partial pressure. Default = PPM.</p>
<p>CH2 DO</p> <p>0.0</p> <p>SALINITY (PSU)</p>	<p>Manually set value to match application (0 - 42 PSU). Practical Salinity Units (1 PSU = 1g/kg, or 1 PPT (Parts per Thousand). Fresh water = 0.00 PSU. Default = 0.00</p>
<p>CH 2 DO</p> <p>1013.20</p> <p>BAROMETRIC</p>	<p>Manually set Barometric value to match application altitude above or below sea level (506.62 - 1114.7 mBAR). Default = 1013.2 (sea level)</p>
<p>CH 2 DO</p> <p>°F</p> <p>TEMP UNITS</p>	<p>Select °F or °C. Default = Determined by the SELECT UNITS screen menu. Metric = °C, U.S. Customary = °F.</p>
<p>CH 2 DO</p> <p>AVERAGE</p> <p>OFF</p>	<p>Dampens display, output and relay response rates. Select Low, Med, High, OFF. (See discussion in Appendix, page 50). Default = OFF.</p>
<p>CH 2 DO</p> <p>TYPE</p> <p>DO</p>	<p>Current channel type is listed. Manually change channel type to match sensor type if sensor is not found by S<sup>3</sup>L search. Default = FACTORY, S<sup>3</sup>L sensors will automatically be found by transmitter. All other sensors must be manually set.</p>



## 9950 Field Software Upgrade

The 9950 upgrade file will be available on the Georg Fischer website. You will need a USB flash drive that is formatted, using Microsoft Windows, in either FAT16 or FAT32 format. **Do not** use exFAT or NTFS formats. These are incompatible with the 9950.

The upgrade file is named Update.Fwc. Copy the file to the root directory of the Flash Drive. Do not change the name of the file or store the file in a sub directory on the Flash Drive. The 9950 will only look in the root directory for the specific file, Update.Fwc.

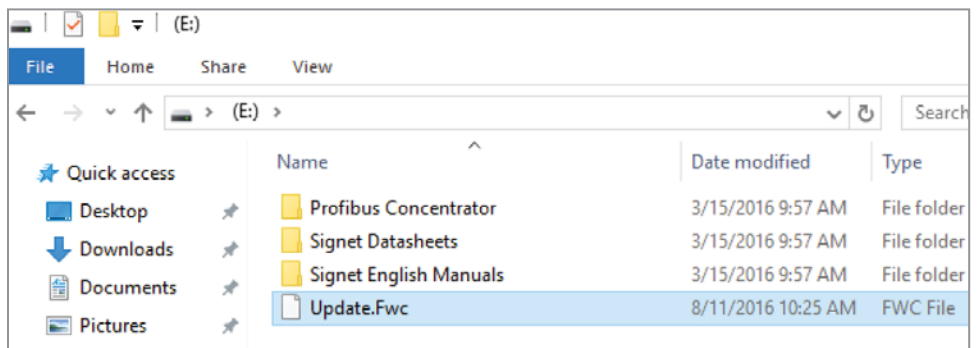

Sample Flash Drive Directory with Update File



**Important!** Do not use a USB extension cable. The USB flash drive must be directly connected to the 9950 USB port.

## Updating the 9950

1. Disconnect power from the 9950.
2. Insert the Flash Drive into the 9950 USB slot.
3. Reconnect power to the 9950.
4. LED 1 on the 9950 will flash quickly as the unit searches for a Flash Drive and the correct file.
5. When the 9950 detects a Flash Drive and a valid update file, LED 2 will slowly flash during the update process.
6. The update process takes approximately 30 seconds.
7. After a successful update the 9950 will boot to the normal screen.
8. After a successful update disconnect power, remove USB drive, reconnect power, review application settings.

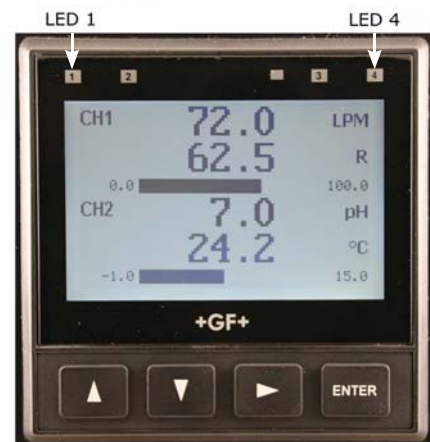

## Troubleshooting

If, after 10 seconds, the unit boots to the normal screen, the 9950 was unable to find the Flash Drive or the file.

- a. Please ensure the Flash Drive has been formatted in either FAT16 or FAT32 format, the upgrade file is in the root directory of the Flash Drive, and the file name is Update.Fwc. You may also need to try a different flash drive.
- b. If LED 4 on the 9950 is continuously illuminated, this indicates either the file found on the Flash Drive is corrupted, or power was interrupted during the upgrade process.
  - Remove power from the 9950.
  - Remove the Flash Drive.
  - Apply power to the 9950.
- c. If the 9950 starts normally, the file on the Flash Drive was corrupted.
  - Download a new copy of the update file and copy it to the Flash Drive.
  - Repeat the update instruction with the new file.
- d. If the 9950 starts up and stops with LED 4 on and a blank screen, this indicates that the update process was interrupted and the 9950 cannot start.
  - Disconnect power from the 9950.
  - Reattach the Flash Drive to the 9950.
  - Repeat the upgrade procedure.
- e. If the 9950 still does not respond after the second upgrade attempt,
  - Download a new copy of the update file and copy it to a different Flash Drive.
  - Repeat the update instruction with the new Flash Drive.

## Troubleshooting

Condition	Possible Causes	Suggested Solution
<b>Wrong Sensor</b>	Incorrect sensor installed on channel	Connect correct sensor to channel
	Sensor Type set incorrectly in 9950	Set correct sensor TYPE in INPUT menu (see page 8)
<b>Wrong Code</b>	Wrong password entered	Enter correct password (see page 20)
<b>K-Factor Out Of Range</b>	K-Factors cannot be set to 0	Enter K-Factor from 0.0001 to 99999
<b>Backlight inoperative</b>	Backlight turned OFF ( <b>NOTE:</b> Backlight can turn off automatically in AUTO mode)	Set BACKLIGHT to LOW, HIGH, AUTO LOW or AUTO HIGH in OPTION menu.
<b>Relays inoperative</b>	Relay Module installed incorrectly	Remove and reseal relay module
	Wrong settings in RELAY menu	Use test relay to verify relay operation then check relay settings.
<b>Relay always on</b>	Hysteresis value too large	Change the hysteresis value
	Defective Relay Module	Replace Relay Module
- - - - -	Measurement exceeds display capability	Increase Flow units time base
		Change unit of measure

## Troubleshooting

Condition	Possible Causes	Suggested Solution
<b>No Probe</b> (pH/ORP only)	9950 "cannot communicate" to sensor	<ul style="list-style-type: none"> <li>• Check wiring</li> <li>• Install or replace sensor</li> </ul>
	Missing sensor or bad temperature element.	
<b>No Sensor</b> (Flow, Cond/Res, Press, Level, Temp, 4-20 mA, Sal, Batch, DO)	9950 "cannot communicate" to sensor	<ul style="list-style-type: none"> <li>• Check wiring</li> <li>• Install or replace sensor</li> </ul>
<b>Check Preamp</b>	9950 "cannot communicate" to the preamp	Check wiring or replace preamp
<b>Backlight of Screen is RED</b>	Error is detected	Correct error condition
<b>Missing Cap</b>	Dissolved Oxygen sensor is missing the sensor cap.	Reinstall Dissolved Oxygen sensor cap
<b>Replace Cap</b>	Dissolved Oxygen sensor cap has expired.	Install new Dissolved Oxygen sensor cap
<b>Broken Glass</b>	pH sensor glass has been damaged, causing very low impedance.	Visually inspect pH/ORP sensor for cracked and/or chipped glass.
<b>Hi Impedance</b>	The measured pH sensor impedance is above the high impedance level.	Visually inspect the pH electrode and clean if necessary.
	Electrode could be in air.	Ensure electrode is submerged at all times.
<b>Check Cal</b> (pH/ORP only)	Slope and/or Offset are out of range	Perform pH EasyCal (pg. 30 & 56)
		Perform ORP EasyCal (pg. 32 & 58)
		Set pH Slope or Standard (pg. 30 & 57)
		Set ORP Slope or Standard (pg. 32 & 59)
		Reset pH CAL (pg. 31)
		Reset ORP CAL (pg. 33)

## Averaging

### ■ ■ ■ ■ ■ NO AVERAGING, NO SENSITIVITY

With SENSITIVITY set to 0 (zero) and AVERAGING set to OFF (0 seconds), the 9950 responds immediately to every shift in the process. The dashed red line represents the actual output of the sensor in varying conditions.

### ■■■■■■■■ AVERAGING ONLY

With SENSITIVITY still set to zero and AVERAGING set to MED or HIGH the rate is stabilized, but a sharp change in rate is not represented for 8 to 32 seconds or longer.

### ■■■■■■■■ AVERAGING AND SENSITIVITY

With SENSITIVITY at 50 and AVERAGING set to MED or HIGH, the rate is stabilized, while a sudden shift in flow rate exceeding 50 units of measure will be displayed immediately.

**NOTE:** The SENSITIVITY function applies only to FLOW.  
The SENSITIVITY function has no effect if the AVERAGING function is set to OFF.

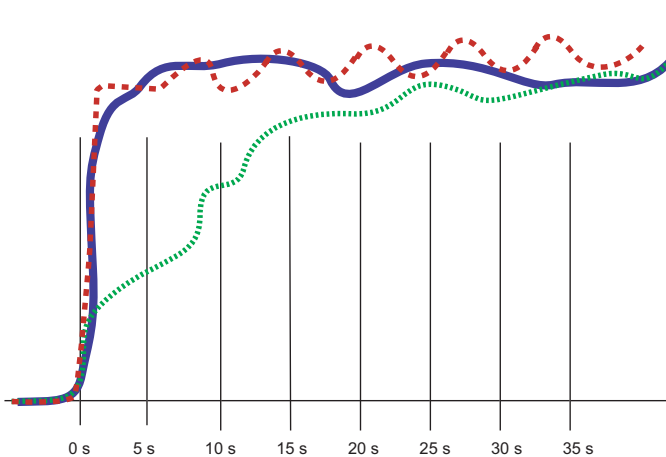

Averaging is different depending on the measurement type. Seconds to 99.5% of Final Value for Low, Med, and High are:

Sensor Type	Low	Medium	High
Flow	10	40	120
pH	2	4	12
ORP	2	4	12
Cond/Res/Salinity	4	6	12
Pressure	4	10	30
Level/Volume	4	10	30
Temperature	3	10	30
4 to 20 mA	4	10	30
Dissolved Oxygen	4	6	12

## LOG Current Loop Output

In Conductivity/Resistivity, the logarithmic (LOG) mode can be used when a very large measurement range is required, yet high resolution is needed at the low end (e.g. in a clean-in-place application where a high-resolution conductivity reading is needed at the low end, while a very high conductivity reading is needed when a cleaning cycle is in progress).

Only two parameters need to be set up, the starting or base conductivity value (4 mA SETPOINT) and the ending or maximum conductivity value (20 mA SETPOINT). The 4 mA setpoint may be larger than the 20 mA point (reverse span).

*What equation should be put in the PLC?*

$$\text{Conductivity} = 10^n$$

$$n = (\text{mA input} - 4.0) \times \frac{(\text{Log}_{10} 20 \text{ mA setpnt} - \text{Log}_{10} 4 \text{ mA setpnt})}{16 \text{ mA}} + \text{Log}_{10} 4 \text{ mA setpnt}$$

If only fixed thresholds are required, they can be calculated in mA. Then the mA value can be checked directly.

Inside the 9950 the following equation is used:

$$\text{mA} = (\text{Log}_{10} \text{Conductivity} - \text{Log}_{10} 4 \text{ mA setpnt}) \times \frac{16}{(\text{Log}_{10} 20 \text{ mA setpnt} - \text{Log}_{10} 4 \text{ mA setpnt})} + 4$$

**NOTE:**

If ADJUST 4 mA or ADJUST 20 mA is used, the mA value can be affected. To prevent any problems the adjust function should only be used to get exactly 4.0 and 20.0 at the PLC. The 9950 is accurate and the adjust functions are only needed to compensate for an offset due to noise or a not-so-accurate PLC input card.

The error value of either 3.6 mA or 22 mA should be tested first before applying the conductivity equation.

Custom Measurements

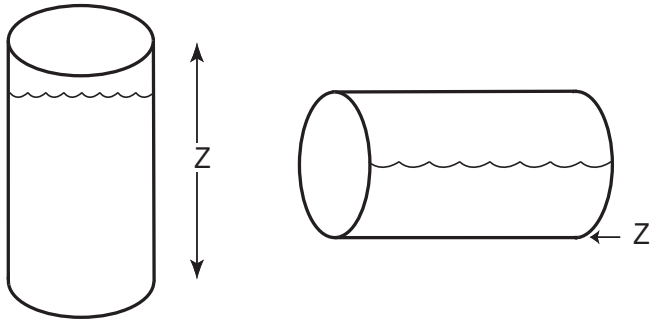

For most vessels, the zero reference point (Z) may be designated as any height in the vessel.

For horizontal cylinders only, the zero reference point MUST be the lowest point in the vessel.

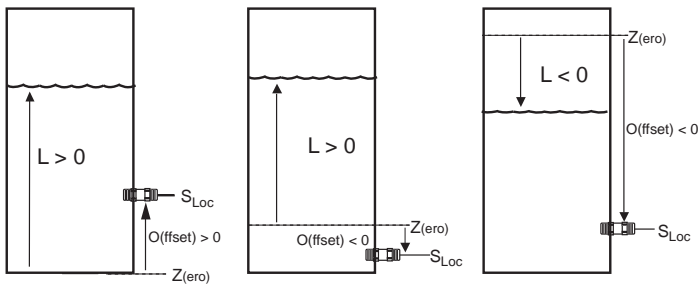

**Defining a Custom Tank**

1. Determine where the level measurement should start. This is the zero reference point (Z). Review the diagram to help select the best option.
2. Determine where you will mount the sensor. This is  $S_{Loc}$ . Consult the Sensor manual for information regarding the best location for the sensor.
3. Measure the distance between Z and  $S_{Loc}$ . This is O(ffset).
4. Enter the Offset into the INPUT Mode menu.

**Zero reference point (Z):**

The point in the vessel where you want the 9950 to display zero (0 ft, 0 gal. etc.).

- If Z is located below the fluid surface, the 9950 will display a positive level measurement.
- If Z is located above the fluid surface, the 9950 will display a negative level measurement.

**Sensor Location point ( $S_{Loc}$ ):**

The point on the level sensor where the measurement is taken.

- The pressure sensor measures from the center line of the diaphragm.

**Offset (O):**

The distance from Z to  $S_{Loc}$ .

- Enter a positive value in the Calibrate menu if the sensor is located above Z.
- Enter a negative value in the Calibrate menu if the sensor is located below Z.
- Enter 0 in the Calibrate menu if the sensor is located at Z.

**Level (L):**

The distance from Z to surface of fluid (displayed as "Level" by 9950).

## Custom Measurements

**Level and Volume Calculation in Custom Shaped Vessels**

In the LEVEL/VOLUME menu, if Custom Shape is selected in the INPUT menu, you can define from three to ten Custom Points to establish the relationship of level to volume in the vessel.

- Select Manual Level Measurement mode to edit both level and volume data (dry configuration).
- Select Automatic Level Measurement mode to accept the sensor measurement of the Level, while you assign a volumetric value to each custom point (wet configuration).
- Enter from 4 to 32 custom points to link level and volume values.
- The first custom point must be the lowest fluid level in the vessel. Each successive point must be greater than the preceding point.
- The last point must be equal to or greater than the highest fluid level in the vessel.
- A custom point should be located at all transition points in the vessel shape (for example, at custom point #9, where the shape changes from a cylinder to a cone).
- The more complex sections should be defined with more points.

**NOTE:** The conical section of the illustration has been defined by custom points 1 through 9. More complex tanks will require additional points to ensure an accurate calculation.

- Simpler sections require fewer defining points.

**NOTE:** A cylinder requires only custom points 9 and 10.

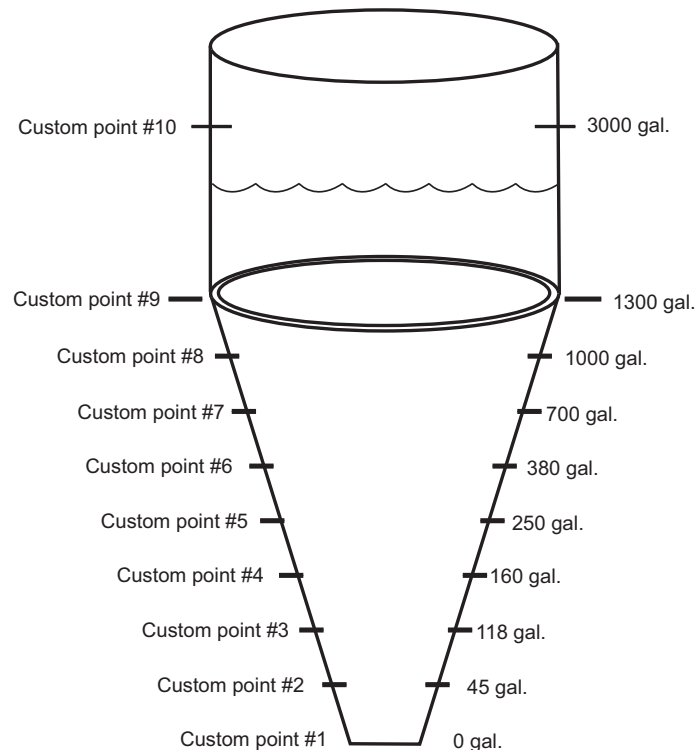

## Custom Measurements

In the LEVEL/VOLUME INPUT menu (see page 40), if SHAPE is set to HORIZ CYLINDER, RECTANGLE or CUSTOM, the tank shape can be defined with the following screens:

<p>CH 2 LEVEL 4 NUM CUST POINTS</p>	<p>If Custom shape is selected, enter the number of measurement points to be used to define the vessel shape (see Level and Volume Calculation in Custom Shaped Vessels discussion, page 52). Minimum 4 points, maximum 32 points. A larger number of points improves accuracy.</p>
<p>CH1 LEVEL AUTO LEVEL CALC</p>	<p>Select (AUTO, MAN). Manual allows you to edit both the Level and the corresponding Volume for your custom tank. Automatic allows you to edit the Volume measurement (while displaying an automatically calculated Level value). See example below.</p>
<p>FT 0.00 POINT 1 LEVEL</p>	<p>Enter the Level (if MAN measurement is selected) at each custom point in your vessel. If AUTO is selected, indication will read actual tank level in LEVEL UNITS at that point in your tank.</p>
<p>GAL 0.00 POINT 1 VOL</p>	<p>Set the Volume (if manual measurement is selected) at each custom point in your vessel.</p>
<p>FT 0.00 POINT X LEVEL</p>	<p>Where (X) is number of custom points used to calculate level.</p>
<p>FT 0.00 POINT X VOL</p>	<p>Where (X) is number of custom points used to calculate volume.</p>

### To set AUTO LEVEL MEAS value:

1. Add a known quantity of fluid into a tank.
  2. POINT 1 LEVEL indicates actual tank level.
  3. Press ▼ for POINT 1 VOL. Press ► to enter quantity of fluid (in VOLUME UNITS) added to the tank in step 1. Press ENTER.
  4. Repeat for each point set in NUM CUST PNTS.
- For example, in a 25-gallon conical tank set for three custom points:
1. Add 10 gallons of fluid into the conical tank. POINT 1 LEVEL will indicate actual tank level.
  2. In POINT 1 VOL, enter 10.
  3. Add another 10 gallons into the tank. POINT 2 LEVEL will indicate actual tank level.
  4. In POINT 2 VOL, enter 10.
  5. Add the final 5 gallons into the tank. POINT 3 LEVEL will indicate actual tank level.
  6. In POINT 3 VOL, enter 5.

Custom Measurements

**Technical Reference for Level, Volume, and Mass Measurement**

The 9950 can automatically perform level, volume and mass calculations:

- Pressure-to-level
- Mass
- Volume

**Pressure to level conversion:**

$$Level = P \div (SG \times D)$$

where P = Pressure  
 SG = Specific Gravity of fluid  
 D = Density of water

With pressure in psi:

$$Level \text{ (meters)} = 0.703069 \times (P/SG)$$

With pressure in bar:

$$Level \text{ (meters)} = 1.019715 \times (P/SG)$$

**Mass Conversion**

$$m = D \times SG \times V$$

where m = mass of fluid  
 D = density of water = 1000 kg/m<sup>3</sup>  
 SG = Specific Gravity of fluid  
 V = Volume of fluid (m<sup>3</sup>)

$$m \text{ (kg)} = 1000 \times SG \times V$$

**Volume Calculations**

Vertical cylinder:

$$V = \pi \times r^2 \times h$$

where r = radius of cylinder  
 h = height of fluid

Rectangular vessel:

$$V = w \times l \times h$$

where w = width  
 l = length  
 h = height

Horizontal cylinder:

$$V = A \times L$$

where A = area of segment  
 L = length of vessel

$$A = \left[ \left( r^2 \times \cos^{-1} \times \frac{r-h}{r} \right) - (r-h) \right] \times \sqrt{2rh - h^2}$$

where r = radius of vessel  
 h = height of segment

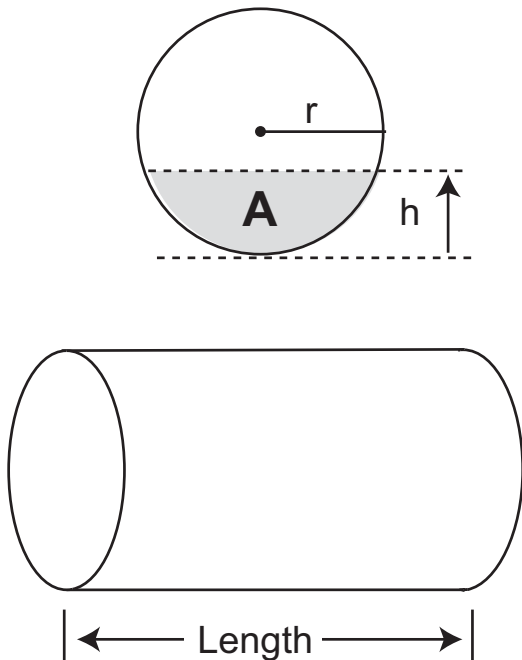





Calibration Procedures - pH

**EasyCal Procedure - pH**

EasyCal is the fastest and simplest periodic calibration method.  
Requires prepared 4, 7 or 10 pH buffers (any two).

To Calibrate:	Response:	To Accept:
<p><b>PLACE SENSOR IN BUFFER 1</b></p> <p>Place electrode tip in first pH buffer. pH 4.0 = 177 mV pH 7.0 = 0 mV pH 10 = -177 mV Limit ± 50 mV</p> 	<p><b>+04.32</b></p> <p>4.00</p> <p>EASY 177.10 mV</p> <p><b>30s</b> Allow for stabilization 30 seconds</p>	<p><b>CH pH</b></p> <p>EASY 177.10 mV</p> <p><b>ENTER</b> to accept</p>
<p><b>PLACE SENSOR IN BUFFER 2</b></p> <p>Place electrode tip in second pH buffer.</p> 	<p><b>+06.76</b></p> <p>7.00</p> <p>EASY 0.00 mV</p> <p><b>30s</b> Allow for stabilization 30 seconds</p>	<p><b>CH 1 pH</b></p> <p>EASY 0.00 mV</p> <p><b>ENTER</b> to accept second buffer calibration</p>

To exit menus and return to VIEW press ▲ and ▼ buttons at the same time.



**NOTE:** The solutions can be used for calibrating more than one sensor; however, the solution must remain free of debris and must not be diluted by rinse water from previous calibrations.

- This procedure simplifies pH calibration using standard 4.0, 7.0, 10.0 pH buffers only. If these pH buffers are not available, use MANUAL CAL and calibrate the system using the STANDARD and SLOPE settings.
- Set sensor temperature in the CAL Mode before performing EasyCal for new electrode installations.

Theoretical mV values  
pH @ 25 °C      mV

2	+296
3	+237
4	+177
5	+118
6	+59
7	+0
8	-59
9	-118
10	-177
11	-237
12	-296

Calibration Procedures - pH

**Manual Calibration Procedure - pH**

Requires prepared buffers. System calibration is possible with two known pH solutions within 0 to 14 pH (buffers of pH 4.01, 7, or 10 are recommended, but use a buffer close to your own process value.)

**To Set Standard:**

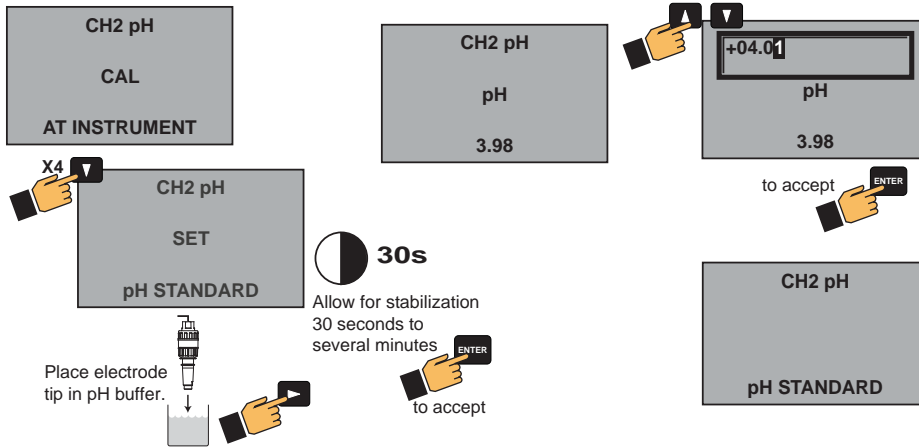

**To Change Reading:**

Single-point calibration sets STANDARD only; Signet recommends a two-point calibration to set SLOPE in addition to STANDARD.

**Quick Manual Calibration Procedures:**

**1-Point Calibration:**

1. Set solution standard.

**2-Point Calibration (recommended):**

1. Set solution standard.
2. Set solution slope.

Refer to page 62 to troubleshoot Calibration Errors

**To Set Slope:**

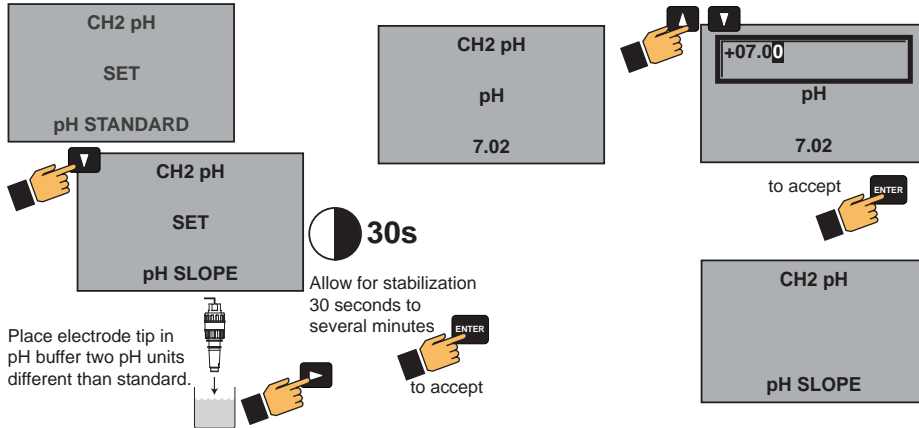

**To Change Reading:**

**To Set Calibration Date:**

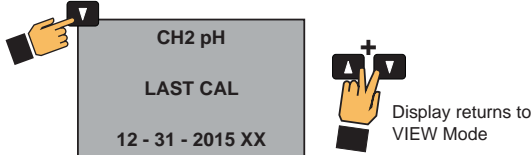

## Calibration Procedures - ORP

**EasyCal Procedure - ORP (one-point calibration)**

EasyCal is the fastest and simplest periodic calibration method.

Requires a prepared quinhydrone solution or Light's Solution:

Saturate 50 mL of pH 7 (87 mV) or pH 4 (264 mV) buffers with 1/8 g quinhydrone.

Premixed Light's Solution (476 mV) can be used instead of pH buffers with quinhydrone.

To Calibrate:

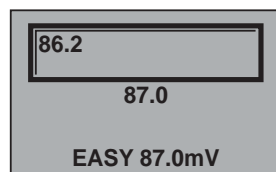

Place electrode tip in saturated pH 7.0 buffer.  
pH 7.0 = 87 mV



Response:

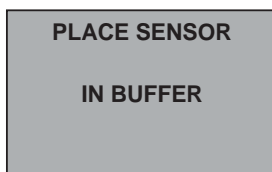

Allow for stabilization  
30 seconds

To Accept:

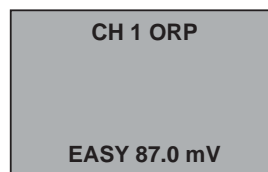

To exit menus and return to VIEW press ▲ and ▼ buttons at the same time.



1. Press ▲ once to display EASY CAL setting.
2. Select the ORP CH you would like to calibrate.
3. Press ► to begin one-point EasyCal.
4. Place sensor in solution:
  - 87 mV (7 pH + quinhydrone)
  - 264 mV (4 pH + quinhydrone)
  - 476 mV (Light's Solution)
5. Press **ENTER**.
6. After 30 seconds, 9950 will recognize current buffer  $\pm 80$  mV.
7. Press **ENTER** to accept mV value.



**NOTE:** ORP solutions made with quinhydrone are very unstable and may not read properly once exposed to air for a prolonged time. These solutions must be disposed of within an hour.

The solution can be used for calibrating more than one sensor. However, the solution must remain free of debris and must not be diluted by rinse water from previous calibrations.

Acceptable ranges for the readings are  $\pm 80$  mV (i.e.,  $87 \pm 80$  mV).

Calibration Procedures - ORP

**Manual Calibration Procedure - ORP**

Requires prepared buffers and a prepared quinhydrone solution:

Saturate 50 mL of pH 4 and 7 buffers with 1/8 g quinhydrone.

(System calibration is possible with two known ORP solutions, but use a buffer close to your own process value).

To Calibrate:

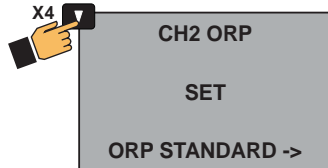
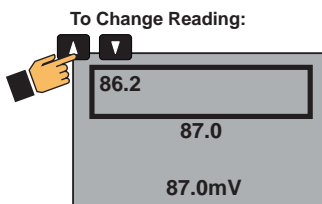
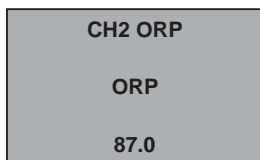
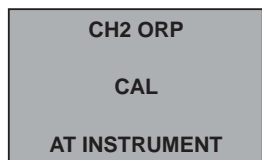

30s  
Allow for stabilization 30 seconds to several minutes

Place electrode tip in saturated pH 7.0 buffer. pH 7.0 = 87 mV

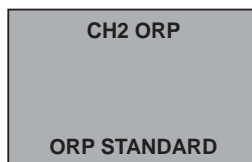

To Set Slope:

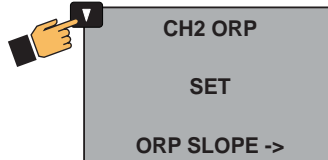
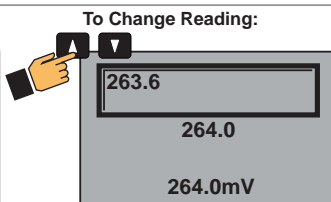
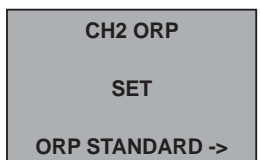
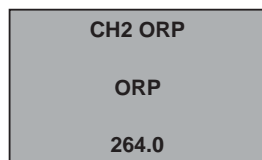

30s  
Allow for stabilization 30 seconds to several minutes

Place electrode tip in saturated pH 4 buffer. pH 4.0 = 264 mV

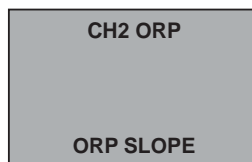

To Set Calibration Date:

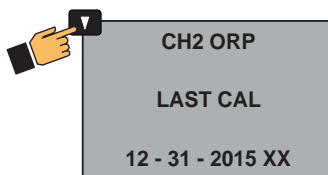

Display returns to VIEW Mode



**NOTE:** ORP solutions made with quinhydrone are very unstable and may not read properly once exposed to air for a prolonged time. These solutions must be disposed of within an hour.

The solution can be used for calibrating more than one sensor. However, the solution must remain free of debris and must not be diluted by rinse water from previous calibrations.

Acceptable ranges for the readings are  $\pm 80$  mV (i.e.,  $87 \pm 80$  mV).

Single-point calibration sets STANDARD only.

**Quick Manual Calibration Procedures:**

**1-Point Calibration:**

1. Set solution standard.

**2-Point Calibration :**

1. Set solution standard.
2. Set solution slope.

Refer to page 62 to troubleshoot Calibration Errors

## Calibration Procedures - Conductivity / Resistivity

### Calibration Procedure - Conductivity/Resistivity

AutoCal is the fastest and simplest periodic calibration method.  
Requires prepared buffer of a value appropriate to your process.

#### AutoCal Procedure

**AutoCal** is a single-point calibration system. During this procedure, if the measured value is within  $\pm 10\%$  of any of the test values listed below, the 9950 will automatically recognize the test value and calibrate the output to that value.

**NOTE:** The first step (Reset) is recommended each time an electrode is replaced, but is NOT necessary upon initial installation or periodic calibration.

**NOTE:** Ensure that the buffer solution is within  $\pm 5^\circ\text{C}$  of  $25^\circ\text{C}$ .

1. Reset the sensor to factory calibration (refer to sensor manual for procedure).
2. On the 9950, select AUTO CAL from the CAL menu. Press **►**.
3. Place the electrode/sensor assembly into the conductivity test solution appropriate to your operating range. Shake the electrode to dislodge any air bubbles visible on the surface of the electrode.
4. Allow at least 2 minutes for the electrode response to stabilize.
5. When the display stabilizes, press ENTER.
6. If calibration is successful, 9950 will display "SAVING". If error is too large, "OUT OF RANGE USE MANUAL CALIBRATION" will display.

Calibration is complete. Return the system to service.

#### Manual Cal Procedure

**NOTE:** The first step (Reset) is recommended each time an electrode is replaced, but is NOT necessary upon initial installation or periodic calibration.

**NOTE:** Ensure that the buffer solution is within  $\pm 5^\circ\text{C}$  of  $25^\circ\text{C}$ .

1. Reset the sensor to factory calibration (refer to sensor manual for procedure).
2. On the 9950, select MANUAL CAL from the CAL menu. Press **►**.
3. Place the electrode/sensor assembly into the conductivity test solution appropriate to your operating range. Shake the electrode to dislodge any air bubbles visible on the surface of the electrode.
4. Allow at least 2 minutes for the electrode response to stabilize.
5. When the display stabilizes, press the **►** key, and then enter the value of the buffer solution using the **▼**, **▲** and **►** buttons.
6. Press ENTER.
7. 9950 will display "SAVING". If error is too large, "ERR TOO LARGE TO CALIBRATE" will display.

Calibration is complete. Return the system to service.

Conductivity units are displayed as selected in the CALIBRATE menu. Resistivity displayed when K $\Omega$  or M $\Omega$  ranges are selected.

Available buffer values are:

- 10
- 100
- 146.93
- 200
- 500
- 1000
- 1408.8
- 5000
- 10,000
- 12856
- 50,000
- 100,000

(all values in  $\mu\text{S}$ )

Refer to page 62 to troubleshoot Calibration Errors

Calibration Procedures - Flow

**Calibration Procedure - Flow**

Select RATE CALIBRATION to match the dynamic flow rate to an external reference. Entering a rate will modify the existing K-Factor.

Select VOLUME CALIBRATION if the flow rate can be determined by filling a vessel of known volume. The 9950 will count the number of pulses generated as the known volume of fluid passes through the sensor, and then use the information to calculate a new K-Factor.

**Rate Calibration Procedure**

1. Press the ► to enter the rate calibration.
2. Allow the flow to stabilize and then press the ►.
3. Using the ▲, ▼, and ► keys, set the flow rate in the text box to match the flow rate of the system.
4. Press ENTER to complete the flow rate calculation.
5. The 9950 displays the newly calculated K-Factor for your reference.  
(If the calculated K-Factor is less than 0.0001 or greater than 999999 (out of range at either extreme), the 9950 displays "ERROR NEW KF OUT OF RANGE" and returns to RATE CAL. If flow is too low to accurately calibrate, the 9950 displays "ERROR FLOW RATE TOO LOW" and returns to RATE CAL.)
6. Press ENTER to accept the new K-Factor (9950 displays "SAVING") or press ▲+▼ keys simultaneously to escape without saving and return to Enter Volume.

**NOTE:** You may enter your own calculated K-Factor in the CAL menu.

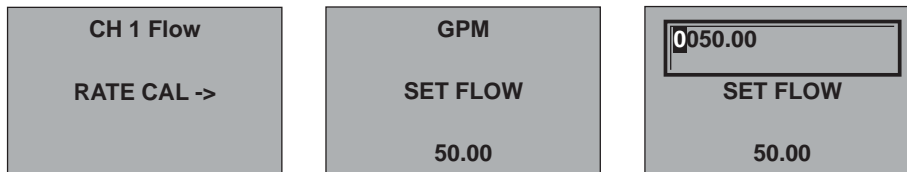

**Volume Calibration Procedure**

1. Press ENTER to start the volumetric calibration period.  
The 9950 starts counting pulses from the flow sensor.
2. Press ENTER to stop the volumetric calibration period.  
The 9950 stops counting pulses from the flow sensor.
3. Enter the volume of fluid known to have flowed past the sensor during the volumetric calibration period. This will modify the existing Flow K-Factor.
4. The 9950 displays the newly calculated K-Factor for your reference.  
(If the calculated K-Factor is less than 0.0001 or greater than 999999 (out of range at either extreme), the 9950 displays "ERROR VOLUME TOO HIGH" (or LOW) and returns to VOLUME CAL.)
5. Press ENTER to accept the new K-Factor (9950 displays "SAVING") or press ▲+▼ keys simultaneously to escape without saving and return to Enter Volume.

**NOTE:** You may enter your own calculated K-Factor in the CAL menu.



Refer to page 62 to troubleshoot Calibration Errors

## Calibration Error Messages

Message	Cause	Solution
Out Of Range Use Manual Calibration	(Cond/Res) Error > 10% in AutoCal	Use manual calibration method
	(pH) Buffer not found; Error > ±1.5 pH units	Use 4, & 7 pH buffers (with quinhydrone for ORP calibration) or Light's Solution
	(ORP) No quinhydrone in buffer Error greater than ±80 mV	Clean sensor and retry EasyCal Use manual calibration method
Err Too Large To Calibrate	(Cond/Res) Manual Cal when error > 100%	Inspect sensor and wiring for damage Clean sensor
	(pH) Offset > 1.3 pH units; Slope error > 100%	Check reference Clean sensor Replace sensor
	(Press) Slope must be < ±50% or offset must be < 2.75 PSI or equivalent.	
	(Sal) Slope error > 1000%	
Error Volume Too Low	User-entered volume too small to calibrate	Correct volume entry Use longer calibration period
Error New KF Out Of Range	The calculated K-Factor too low or high	Verify volume or rate entered Verify flow is present
Error Flow Rate Too Low	(Rate Cal) Flow too low to accurately calibrate	Increase flow
Cal Error Out Of Range	(4 to 20 mA) Slope error > 100	Check input at 4 mA and 20 mA settings
	(Temp) Offset must be < ±20 °C or equivalent.	Check sensor range Check reference Replace sensor
Slope Too Close To Standard	(4 to 20 mA) Difference in calibration values must be > 0.1 units	Check sensor Use fresh buffer Use two different buffer values Clean sensor
	(pH) Difference in calibration values must be > 2 pH units	
	(ORP) Difference in calibration values must be > 30 mV	
Standard Too Close To Slope	(4 to 20 mA) Difference in calibration values must be > 0.1 units	Clean sensor Use fresh 4, 7, 10 pH buffers Use two different buffer values
	(pH) Difference in calibration values must be > 2 pH units	
	(ORP) Difference in calibration values must be > 30 mV	
Level Offset Too Large	Offset must be < 1.0 meter	Decrease offset Replace sensor
Pressure Too High	Pressure must be lower than 2.5 PSI or equivalent to do zero cal.	Decrease pressure
Pressure Too Close To Zero	Pressure must be higher than 3 PSI or equivalent to do slope calibration.	Increase pressure Check reference

## USP Limits

USP (United States Pharmacopeia) has defined a set of conductivity values (limits) to be used for pharmaceutical water. The standard requires that conductivity measurement without temperature compensation be used for these applications. The limits vary according to the temperature of the sample. The 9950 has the USP limits stored in memory. It will automatically determine the proper USP limit based on the measured temperature. Important Conductivity TEMP COMP must be set to NONE and Unit Of Measure must be set to  $\mu\text{S}$ .

### Using the USP function

USP setpoints are defined as a percentage below the USP limit, so a USP alarm is always a HIGH alarm. The 9950 can be set to warn you if the conductivity approaches within a set percentage of the USP limit.

The following settings and conditions are required for a USP relay function:

1. In the RELAY menu:
  - RELAY MODE must be set to **USP**.
2. In the INPUT menu:
  - COND UNITS must be set to  **$\mu\text{S}$** .
  - TEMP COMP must be set to **None**.

Example:

- The water temperature is 19 °C, so the USP limit is 1.0  $\mu\text{S}$ .
- The USP PERCENT is set to 40%.
- The relay will be activated when the conductivity value reaches 40% below the 1.0 USP limit, or 0.6  $\mu\text{S}$ .
- If the water temperature drifts to more than 20 °C, the 9950 will automatically adjust the USP limit to 1.1. The relay will now be activated when the conductivity value reaches 40% below 1.1  $\mu\text{S}$  (0.66  $\mu\text{S}$ ).



**NOTE:** Relay will activate if USP limit is exceeded, Temperature Comp is set to Linear or Pure Water, Conductivity Measurement is NOT in  $\mu\text{S}$ , or if the Conductivity Sensor Electronics is indicating a measurement error.

Temperature Range (°C)	USP limit ( $\mu\text{S}$ )
0 to < 5	0.6
5 to < 10	0.8
10 to < 15	0.9
15 to < 20	1.0
20 to < 25	1.1
25 to < 30	1.3
30 to < 35	1.4
35 to < 40	1.5
40 to < 45	1.7
45 to < 50	1.8
50 to < 55	1.9
55 to < 60	2.1
60 to < 65	2.2
65 to < 70	2.4
70 to < 75	2.5
75 to < 80	2.7
80 to < 85	2.7
85 to < 90	2.7
90 to < 95	2.7
95 to < 100	2.9
100 to < 105	3.1

## Maintenance

- Clean the instrument case and front panel with a soft cotton cloth dampened with a mild liquid soap solution.
- Never wipe the front window with static retentive cloths such as wool or polyester which may induce a static charge. If a static charge develops on the window, you may notice temporary blotches form on the screen. When this occurs, clean the front window with an anti-static cloth, or a soft cotton cloth and anti-static spray or a mild liquid soap solution to remove the static charge.



Map of 9950 Relay and Loop Sources

Measurement

Loop and Relay Control Parameters

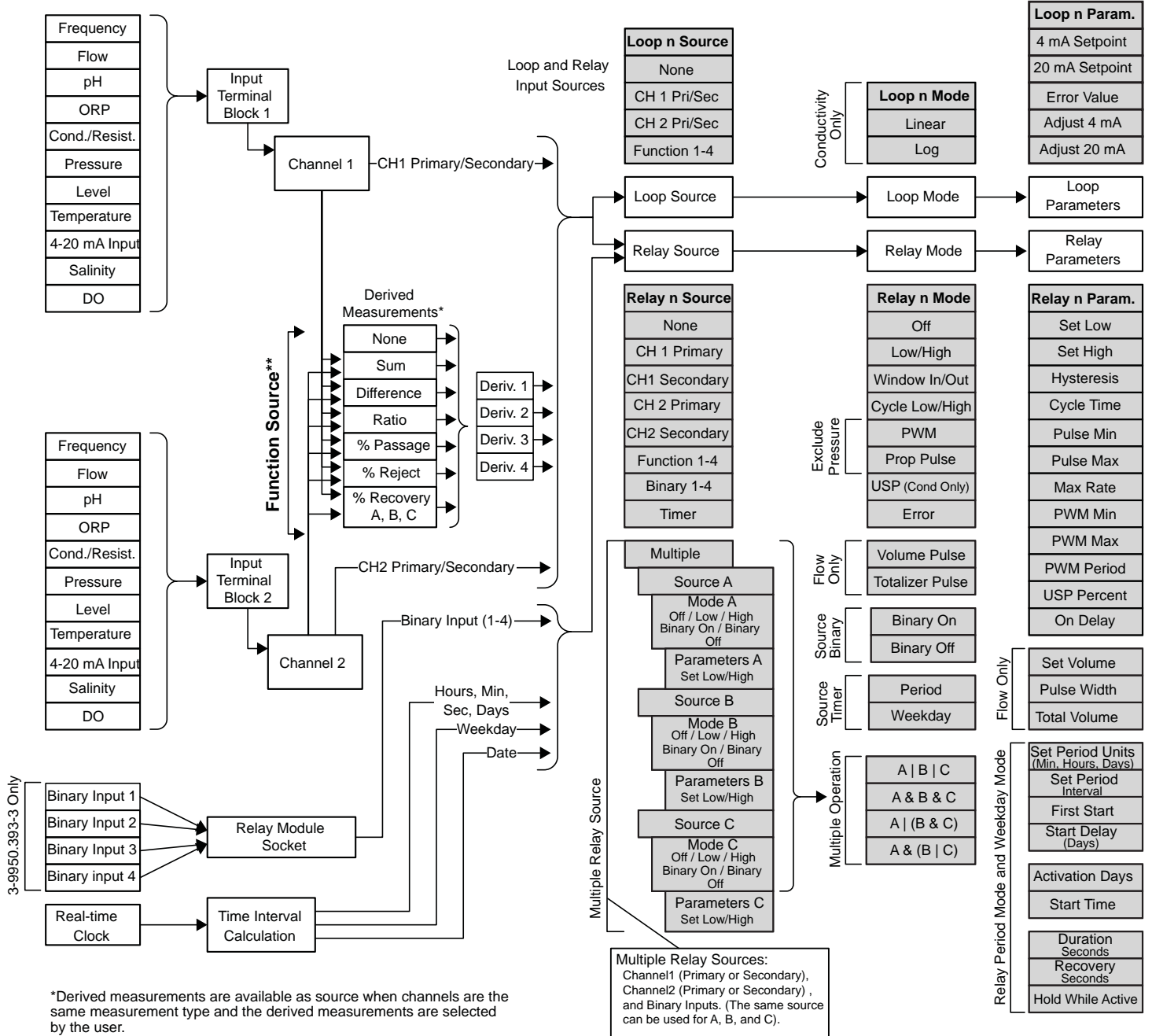

\*Derived measurements are available as source when channels are the same measurement type and the derived measurements are selected by the user.

\*\*CH1 + CH2, CH1 - CH2, CH2 - CH1, CH1 ÷ CH2, CH2 ÷ CH1.

## Specifications

### General

Input channels.....	Two channels, programmable for Digital (S <sup>3</sup> L) or frequency input
Outputs.....	Two passive 4 to 20 mA loop outputs standard Two or four programmable relay outputs optional

### Enclosure and Display

Case Material .....	PBT
Window.....	Shatter-resistant glass
Keypad .....	4 buttons, injection-molded silicone rubber seal
Display.....	Dot Matrix LCD
Update Rate .....	1 s
LCD Contrast.....	5 settings
Indicators.....	Two horizontal digital bar graphs, four LED relay status indicators

### Enclosure

Size .....¼ DIN

### Mounting

Panel .....	¼ DIN, ribbed on four sides for panel mounting clip inside panel, silicon gasket included
Wall.....	Large enclosure (sold as an accessory)

### Terminal Blocks

Pluggable screw type: use minimum 105 °C rated wire  
Torque ratings

Power/Loop.....	0.49 Nm (4.4 lb-in.)
Freq/S <sup>3</sup> L.....	0.49 Nm (4.4 lb-in.)
Relay.....	0.49 Nm (4.4 lb-in.)

### Connector wire gauge:

Power, Loop.....	12 to 28 AWG
Freq/S <sup>3</sup> L.....	16 to 28 AWG

### Module connector wire gauge:

Relay.....	12 to 28 AWG
------------	--------------

### Environmental

#### Ambient Temperature:

DC Power .....	-10 °C to 70 °C (14 °F to 158 °F)
AC Power .....	-10 °C to 60 °C (14 °F to 140 °F)
Storage Temp .....	-15 °C to 70 °C (5 °F to 158 °F)
Relative Humidity.....	0 to 100% condensing for (front only); 0 to 95% non-condensing (rear panel)

Maximum Altitude .....4,000 m (13,123 ft)

Enclosure Rating.....NEMA 4X/IP65 (front face only)

Installation Category Cat II

Pollution Degree 2

### Performance Specifications

#### System Accuracy

- Primarily dependent upon the sensor.

#### System Response

- Primarily dependent upon the sensor. Controller adds a maximum of 150 ms processing delay to the sensor electronics.
- Minimum update period is 100 ms
- System response is tempered by the display rate, output averaging and sensitivity feature.

### Electrical Requirements

#### Power to Sensors

Voltage.....	+4.9 to 5.5 VDC @ 25 °C, regulated
Current.....	30 mA Maximum

Short Circuit.....Protected

Isolation .....

Low voltage (< 48 V AC/DC)
----------------------------

### Power Requirements

DC (3-9950-1, 3-9950-2).....	24 VDC nominal (12 to 32 VDC, ±10% regulated). A UL60950-1 or UL61010-1 certified power supply must be used. Power supply shall also be rated for operation at 4000 m altitude.
AC (3-9950-2).....	100-240 VAC 50-60 Hz, 24 VA max
Maximum Current.....	200 mA (w/o optional relay module)* 500 mA (with optional relay module)*
Current Loop .....	12 to 32 VDC, ±10% regulated 4 to 20 mA (30 mA max.)
Overvoltage protection .....	48 V Transient Protection Device (for DC ONLY)
Current limiting for circuit protection	
Reverse-Voltage protection	

\*The current draw of the other modules and the sensors are minimal

### Sensor Input Specifications

Digital (S <sup>3</sup> L) Sensors .....	Serial ASCII, TTL level, 9600 bps
Frequency (Flow) Sensors:	0.5 to 1500 Hz
Accuracy.....	± 0.5% of reading max error @ 25 °C
Resolution.....	1 µs
Repeatability.....	± 0.2% of reading
Power Supply	
Rejection.....	No Effect ± 1 µA per volt
Short Circuit.....	Protected
Reverse Polarity .....	Protected
Update Rate .....	(1/frequency) + 100 ms

### Shipping Weights

Base Unit.....	0.63 kg (1.38 lb)
Relay Module.....	0.19 kg (0.41 lb)

### Standards and Approvals

- CE, UL, CUL, WEEE
- RoHS Compliant
- China RoHS (Go to [www.gfsignet.com](http://www.gfsignet.com) for details)

### FC Declaration of Conformity according to FCC Part 15

This device complies with Part 15 of the FCC rules.

Operation is subject to the following two conditions:

- (1) This device may not cause harmful interference, and
- (2) This device must accept any interference received, including interference that may cause undesired operation.

- Manufactured under ISO 9001 for Quality, ISO 14001 for Environmental Management and OHSAS 18001 for Occupational Health and Safety.

Graphical User Interface created with emWin licensed by SEGGER

## Specifications

### Binary Input Specifications (3-9950.393-3)

Input voltage range  
(without damage)..... -5 VDC to 30 VDC  
(no operation below 0 VDC)

Max. Voltage Rating ..... 30 VDC  
Max. Current Rating ..... 6.0 mA

Maximum input voltage for  
signal "Off" (low or "0") ..... 1.5 VDC  
Minimum input voltage for  
signal "On" (high or "1")..... 3.0 VDC  
Maximum current draw for  
signal "0" (low):..... ≤500 µA DC  
Minimum current draw for  
signal "1" (high): ..... 500 µA  
Typical current draw for  
signal "1" (high): ..... 6.0 mA at 30 VDC  
4.8 mA at 24 VDC  
2.4 mA at 12 VDC  
1.0 mA at 5 VDC

### Current Loop Specifications

Current Loop Out..... ANSI-ISA 50.00.01 Class H (Passive,  
external voltage required)  
Voltage..... 12 to 32 VDC, ±10% regulated. Use  
UL60950-1 or UL61010-1 certified  
power supply. Power supply shall  
also be rated for operation at  
4000 m altitude.  
Max. Impedance: ..... 250 Ω @ 12 VDC  
500 Ω @ 18 VDC  
750 Ω @ 24 VDC  
Span ..... 3.8 to 21 mA Adjustable, reversible  
Accuracy..... ± 32 µA max. error @ 25 °C @ 24  
VDC  
Resolution..... 6 µA or better  
Temp. Drift ..... ± 1 µA per °C  
Isolation ..... Low voltage (< 48 VAC/DC)  
Update Rate ..... 100 mS nominal  
Zero ..... 4.0 mA factory set; user programmable  
from 3.8 to 5.0 mA  
Full Scale..... 20.00 mA factory set; user  
programmable from 19.0 to 21.0 mA  
Power Supply Rejection ± 1 µA per V  
Actual update rate determined by sensor type  
Short circuit and reverse polarity protected  
Adjustable span, reversible  
Error Condition ..... Selectable error condition 3.6 or 22 mA  
or None  
Test Mode ..... Increment to desired current  
(range 3.8 to 21.00 mA)  
Analog Outputs..... 2 Passive

### Relay Specifications

Dry-Contact Relays  
Type..... SPDT  
Form ..... C  
Max. Voltage Rating ..... 30 VDC or 250 VAC  
Max. Current Rating ..... 5 A resistive

### Solid-State Relays

Type..... SPDT  
Form ..... C  
Max. Voltage Rating ..... 30 VDC or 30 VAC  
Max. Current Rating ..... 0.050 A

Hysteresis..... Adjustable (absolute in  
Engineering Units)  
On Delay..... 9999.9 seconds (max.)  
Cycle Delay ..... 99999 seconds (max.)  
Test Mode..... Set On or Off  
Maximum Pulse Rate ..... 300 pulses/minute  
Proportional Pulse ..... 300 pulses/minute  
Volumetric Pulse Width..... 0.1 to 3200 s  
PWM period..... 0.1 to 320 s

### Input Types

- Digital (S<sup>3</sup>L) or AC frequency
- 4 to 20 mA input via the 8058 iGo Signal Converter
- Open collector
- pH/ORP input via the Digital (S<sup>3</sup>L) output from the 2750/2751 pH/ORP Sensor Electronics
- Raw Conductivity/Resistivity via the Digital (S<sup>3</sup>L) output from the 2850 Conductivity/Resistivity Sensor Electronics

### Sensor Types:

Flow, pH/ORP, Conductivity/Resistivity, Pressure, Temperature, Level/Volume, Salinity, Dissolved Oxygen, Other (4 to 20 mA)

### Current Outputs

- Two 4 to 20 mA output in base unit
- Linear scaling
- Logarithmic scaling for Conductivity
- Reverse span
- Selectable error mode: 3.6 mA or 22 mA or None
- Test Output mode: allows testing of the current output
- Adjustable 4 to 20 mA end points

### Display Ranges:

pH.....-1.00 to 15.00 pH  
pH Temp. ....-99 °C to 350 °C (-146 °F to 662 °F)  
ORP.....-1999 to +1999.9 mV  
Flow Rate .....-9999 to 99999 units per second,  
minute, hour or day  
Totalizer .....0.00 to 99999999 units  
Conductivity .....0.0000 to 99999 µS, mS, PPM and  
PPB (TDS), kΩ, MΩ  
Cond. Temp. ....-99 °C to +350 °C (-146 °F to 662 °F)  
Temperature .....-99 °C to +350 °C (-146 °F to 662 °F)  
Pressure .....-40 to 1000 psi  
Level .....-9999 to +99999 m, cm, ft, in, %  
Volume .....0 to 99999 cm<sup>3</sup>, m<sup>3</sup>, in<sup>3</sup>, ft<sup>3</sup>, gal, L, lb, kg, %  
Salinity .....0 to 100 PPT  
Dissolved O<sub>2</sub>.....0 to 50 mg/L, 0 to 200%

## Ordering Information

### 9950 Transmitter Base Unit: Dual Channel, Multi-Parameter, AC Power and DC Power

Mfr. Part No	Code	Description
3-9950-1	159 001 841	9950 Base Unit – Two Channel Multi-Parameter Inputs, Two 4 to 20 mA Outputs, Panel Mount, DC Power
3-9950-2	159 001 842	9950 Base Unit – Two Channel Multi-Parameter Inputs, Two 4 to 20 mA Outputs, Panel Mount, AC or DC Power

#### Optional Modules

3-9950.393-1	159 310 268	Relay Module with 4 Mechanical Relays
3-9950.393-2	159 310 269	Relay Module with 2 Mechanical and 2 Solid State Relays
3-9950.393-3	159 310 270	Relay Module with 2 Mechanical Relays and 4 Binary Inputs

#### Accessories

3-8050.396	159 000 617	RC Filter Kit (for relay use), 2 per kit
3-8058-1	159 000 966	i-Go® Signal Converter, wire-mount
3-9950.391	159 310 278	Connector Kit, In-Line, 9950 Transmitter
3-9950.392	159 310 279	Relay Module Connector Kit, 9950 Transmitter
3-9900.392	159 001 700	Wall Mount Enclosure Kit
3-9000.392-1	159 000 839	Liquid Tight Connector Kit, NPT (1 pc.)
3-5000.399	198 840 224	5 x 5 inch Retrofit Adapter
3-8050.392	159 000 640	CR200 ¼ DIN Retrofit Adapter



Georg Fischer Signet LLC, 3401 Aero Jet Avenue, El Monte, CA 91731-2882 U.S.A. • Tel. (626) 571-2770 • Fax (626) 573-2057  
For Worldwide Sales and Service, visit our website: [www.gfsignet.com](http://www.gfsignet.com) • or call (in the U.S.): (800) 854-4090  
For the most up-to-date information, please refer to our website at [www.gfsignet.com](http://www.gfsignet.com)